



PLASTERBOARD

INSTALLATION MANUAL

TABLE OF CONTENTS

PREFACE	3	GARAGE AND EXTERNAL CEILINGS	28
INTRODUCTION	3	GENERAL	28
STANDARDS	3	DESIGN NOTES	28
PLASTERBOARD AND ITS PROPERTIES	4	INSTALLATION OF GARAGE CEILINGS	29
PLASTERBOARD FEATURES AND BENEFITS	4	INSTALLATION OF EXTERNAL CEILINGS	30
PLASTERBOARD TYPES	5	FRAMED WALLS	32
DIMENSIONAL STABILITY	6	FIXING WITH COMBINATION OF ADHESIVE AND FASTENERS	32
THERMAL RESISTANCE	6	FIXING WITH SCREWS ONLY	32
FIRE RESISTANCE	6	FIXING WITH NAILS ONLY	33
FIRE HAZARD PROPERTIES	6	BUTT JOINTS IN WALLS	33
IMPACT RESISTANCE	6	INTERNAL CORNERS	34
MOISTURE RESISTANCE	6	CONTROL JOINT INSTALLATION	35
SUSTAINABILITY	7	DOOR JAMBS	36
SAFETY	7	SHADOWLINE STOPPING ANGLE	36
FIRST AID	7	WALL-CEILING JUNCTIONS	37
DESIGN CONSIDERATIONS	8	MASONRY WALLS	38
CONDENSATION	8	GENERAL	38
VENTILATION	8	INSTALLATION USING MASONRY ADHESIVE METHOD	38
DEVICES GENERATING HEAT	9	INSTALLATION USING FURRING CHANNELS	40
ROOF SARKING	9	WET AREAS	41
ACOUSTICS	9	REGULATORY REQUIREMENTS	41
ATTACHMENTS	10	USG BORAL WET AREA SYSTEM	43
WALLS ON BOUNDARY	10	CURVES AND ARCHES	53
ATTACHED DWELLINGS	10	CONSTRUCTING CURVED WALLS AND CEILINGS	53
CONTROL JOINTS	10	ARCHES	53
LEVELS OF FINISH	11	CORNICES	55
GLANCING LIGHT	13	USG BORAL CORNICES	55
LINING MATERIALS	14	HANDLING AND LAYOUT	56
PLASTERBOARD	14	CUTTING CORNICE	56
MATERIAL QUANTITIES	16	FIXING CORNICE	57
DELIVERY, HANDLING AND STORAGE	17	MIXING CORNICE ADHESIVE	57
FRAMING	18	JOINTING	58
FRAMING CHECK	18	GENERAL	58
FIXING FACE REQUIREMENTS	18	JOINTING COMPOUNDS	58
TIMBER FRAMING	18	USG BORAL JOINTING COMPOUNDS	59
STEEL FRAMING	18	JOINTING TAPES	60
LININGS LAYOUT	19	STOPPING RECESSED JOINTS	60
PLASTERBOARD FIXING	20	STOPPING BUTT JOINTS	62
FASTENING SYSTEMS	20	STOPPING CORNERS	63
GENERAL SCREW AND NAIL FIXING	20	TOOLS AND ACCESSORIES	65
PLASTERBOARD FASTENERS	20	MECHANICAL JOINTING TOOLS	66
INTERNAL CEILINGS	21	DECORATING PLASTERBOARD LININGS	67
CEILING LOADS AND SPANS	21	CONTACTS	68
CEILING SUPPORT OPTIONS	22		
METAL FURRING CHANNELS AND BATTENS	23		
CONTROL JOINTS	24		
FIXING TO CEILINGS	24		

PREFACE

USG Boral is a plasterboard and ceilings Joint Venture between USG Corporation and Boral Limited, and is one of the leading players in this field.

Operating throughout Asia, Australasia and in the Middle East, USG Boral combines USG's innovative building products technologies with Boral's extensive plasterboard manufacturing and distribution footprint in Asia and Australasia.

In Australia USG Boral operates plasterboard manufacturing plants in Queensland, New South Wales and Victoria; a specialty plasters and jointing compounds plant in Victoria and cornice plants in New South Wales and Victoria. The company's products are supplied through a nation-wide distribution network of around 100 company-owned stores and specialised resellers as well as hundreds of hardware stores.

For more information on USG Boral refer to www.usgboral.com

INTRODUCTION

This manual is intended for use by plastering contractors and builders. It outlines recommended methods for installation, jointing and finishing of USG Boral plasterboard linings in non-fire rated residential construction including general areas, wet areas, garage ceilings and shielded external ceilings.

Refer to USG Boral Systems+ and relevant system publications for fire rated and acoustic construction details.

While this manual outlines plasterboard installation specifications for timber framed construction, similar installation, jointing and finishing details apply to steel framed buildings. Refer to relevant USG Boral publications for steel framed plasterboard construction details.

Installation specifications outlined in this manual apply to Level 4 finish, unless noted otherwise (see Levels of Finish).

STANDARDS

The following Australian and other Standards are referenced in this publication:

- AS/NZS 2588 *Gypsum plasterboard*
- AS/NZS 2589 *Gypsum linings – Application and finishing*
- AS 3740 *Waterproofing of domestic wet areas*
- AS/NZS 4858 *Wet area membranes*
- AS 1684 *Timber framed construction*
- AS 4440 *Installation of nailplated timber roof trusses*
- AS/NZS 1170.2 *Wind actions*
- AS 1397 *Steel sheet and strip – hot dipped, zinc coated or aluminium/zinc coated*
- AS 3700 *Masonry structures*
- AS/NZS 2918 *Domestic solid-fuel burning appliances – Installation*
- AS/NZS 5601 *Gas installations*
- *National Association of steel-framed housing (NASH) standard for residential and low-rise steel framing*
- AS 3566 *Self-drilling screws for the building and construction industries*
- AS 1145.3 *Determination of tensile properties of plastic materials Part 3: Test conditions for films and sheets*
- AS/NZS 1716 *Respiratory protective devices*
- ISO 9002 *Quality systems – Model for quality assurance in production, installation and servicing*
- AS/NZS 2311 *The painting of buildings*
- AS/NZS 4600 *Cold-formed steel structures.*

PLASTERBOARD AND ITS PROPERTIES

Invented by USG more than 100 years ago, plasterboard has become the most common dry lining material for walls and ceilings in modern building construction. A breakthrough SHEETROCK® technology developed by USG in recent years has resulted in a lighter and at the same time stronger product than standard plasterboard.

Manufactured on a continuous production line, plasterboard is comprised of a specially formulated gypsum core encased between heavy duty paper liners. Locally manufactured USG Boral plasterboard products utilise naturally occurring gypsum and 100% recycled paper.

Plasterboard sheets are commonly available in 1200mm and 1350mm widths and have recessed longitudinal edges facilitating a smooth, seamless joint finish.

USG Boral plasterboard products meet the requirements of AS/NZS 2588 *Gypsum plasterboard*.

PLASTERBOARD FEATURES AND BENEFITS

- Lightweight
- Cost effective
- Versatile
- Easy to install to timber, steel and masonry substrates
- Provides smooth, stable base for paint and other decorative finishes
- Contains recycled materials.

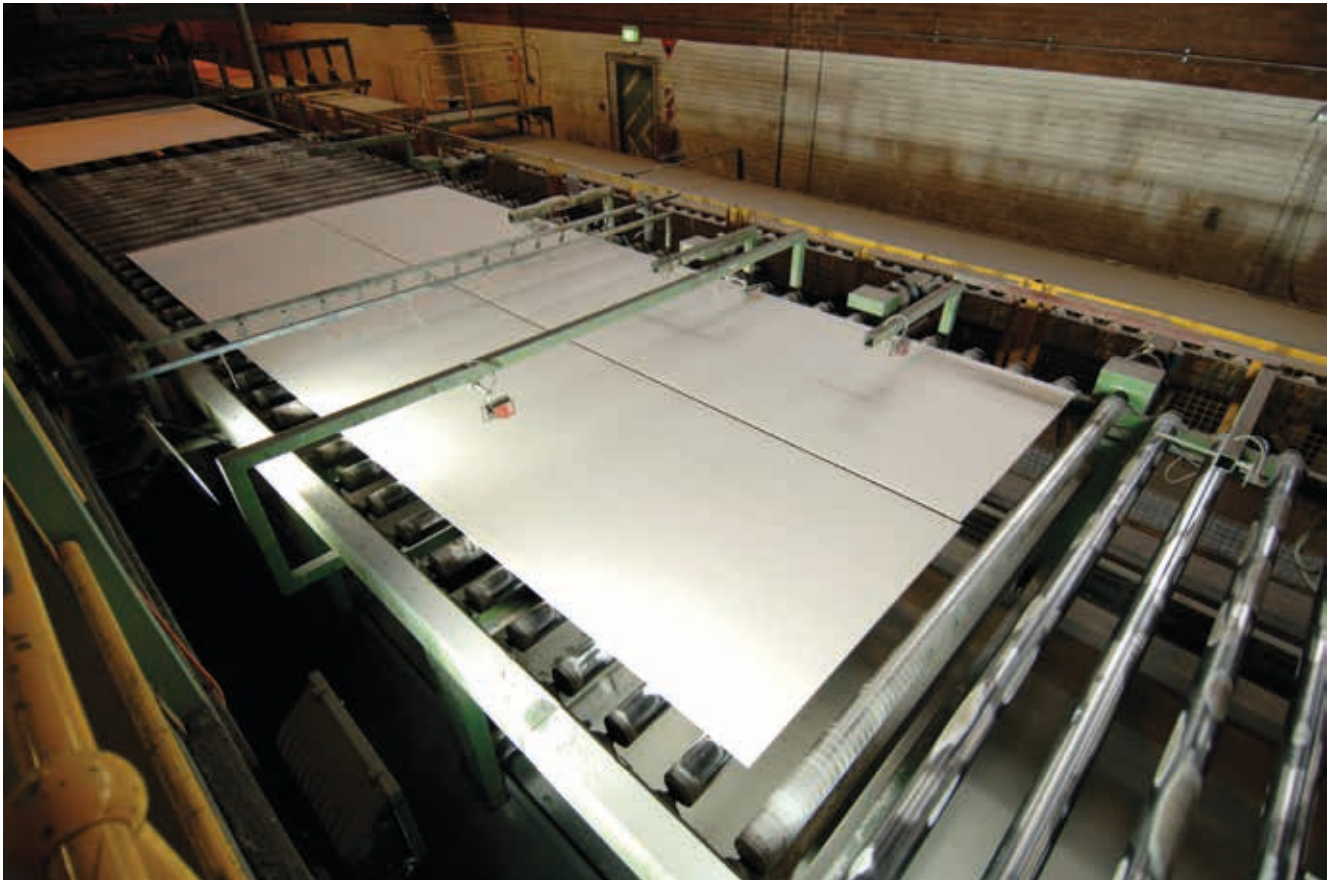







Figure 1: **Plasterboard Line**

» PLASTERBOARD AND ITS PROPERTIES

PLASTERBOARD TYPES

USG Boral supplies a number of plasterboard types to suit various applications:

TABLE 1: PLASTERBOARD TYPES														
PLASTERBOARD TYPE	THICKNESS (mm)	LIGHTWEIGHT	SAG	WATER	FIRE	SOUND	ECHO	IMPACT MODERATE	IMPACT HIGH	IMPACT VERY HIGH	FLEXIBLE	MOULD	X-RAY	GECA
SHEETROCK® Wall Board	10	●												●
SHEETROCK® Standard	13	●												●
SHEETROCK® Ceiling Board	10	●	●											●
STANDARD Plasterboard	10 13													13mm
UNISPAN®	10		●											
FLEXIBOARD®	6.5									●				
SOUNDSTOP®	10 13					●								13mm
WETSTOP™	10 13			●										13mm
FIRESTOP®	13 16				●	●								●
FIRE+WETSTOP™	13 16			●	●	●								●
MULTISTOP™ 	13				●	●		●						●
MULTISTOP™ 	13			●	●	●		●						●
MULTISTOP™ 	13			●	●	●		●				●		●
MULTISTOP™ 	13				●	●		●						
MULTISTOP™ 	13			●	●	●		●						
MULTISTOP™ 	13			●	●	●		●				●		
FIBEROCK®	10 13 16			●	●	●			●			●		●
SHAFTLINER™	25				●	●								●
X-BLOCK®	13				●	●							●	ECNZ
ECHOSTOP®	12.5						●							

» PLASTERBOARD AND ITS PROPERTIES

DIMENSIONAL STABILITY

Under normal ambient temperature and humidity conditions, plasterboard has the following expansion properties:

Thermal Coefficient of Linear Expansion:

16.2 x 10⁻⁶ mm / (mm°C) at temperature range 4 to 38°C

Hygrometric Coefficient of Expansion:

7.2 x 10⁻⁶ mm / mm%RH (5 to 90%RH)

THERMAL RESISTANCE

The R-values of some USG Boral products are provided in the following table:

TABLE 2: THERMAL RESISTANCE	
PLASTERBOARD TYPE	R-VALUE
10mm STANDARD 10mm SHEETROCK	0.056m ² K/W ±10%
13mm STANDARD 13mm SHEETROCK	0.073m ² K/W ±10%
10mm FIBEROCK	0.038m ² K/W ±10%
13mm FIBEROCK	0.049m ² K/W ±10%

FIRE RESISTANCE

Plasterboard is deemed to be a non-combustible material for the purposes of the National Construction Code (NCC).

While plasterboard inherently possesses a certain degree of fire resistance due to the chemical composition of the gypsum core, the following USG Boral products have enhanced fire resistance properties and are specifically formulated for use in fire rated construction:

- FIRESTOP
- FIRE WETSTOP
- MULTISTOP
- FIBEROCK
- SHAFTLINER.

FIRE HAZARD PROPERTIES

Wall and ceiling lining materials in certain types of buildings must comply with the Fire Hazard Properties requirements of the NCC.

All USG Boral plasterboard lining products are classified as Group 1 (least hazardous) materials and have a smoke growth rate index less than 100 and average specific extinction area less than 250 m²/kg when tested in accordance with the NCC.

IMPACT RESISTANCE

USG Boral offers a number of lining products specifically developed for applications requiring enhanced impact resistance:

TABLE 3: IMPACT RESISTANT LINING PRODUCTS	
PRODUCT	RELATIVE IMPACT RESISTANCE
MULTISTOP	Moderate
MULTISTOP HI	High
FIBEROCK	Very high

MOISTURE RESISTANCE

Although plasterboard is not a waterproof material, USG Boral offers a number of lining products classified as moisture resistant under the NCC requirements for domestic wet areas. These products include:

- WETSTOP
- FIRE WETSTOP
- FIBEROCK
- MULTISTOP 4, 4HI, 5, 5HI.

» PLASTERBOARD AND ITS PROPERTIES

SUSTAINABILITY

RAW MATERIALS

Gypsum used in locally manufactured USG Boral plasterboard products is mined from abundant resources at Kevin in South Australia. The mine has in place a rehabilitation and revegetation strategy aimed at creating a landscape with natural appearance and native local vegetation.

Plasterboard paper liner is manufactured from 100% recycled waste paper fibre and contains no virgin paper fibre.

FIBEROCK gypsum board contains 95% recycled content.

PLASTERBOARD MANUFACTURE

Apart from natural gypsum and recycled paper, the key inputs in the plasterboard manufacturing process are natural gas and potable water.

All USG Boral Australia plasterboard production facilities are certified under ISO 9002 *Quality systems – Model for quality assurance in production, installation and servicing*.

USG Boral aims at exceeding the local Environment Protection requirements and at maximising the use of recycled water at its manufacturing facilities.

PLASTERBOARD RECYCLING

Plasterboard waste can be recycled into new plasterboard or as soil conditioner.

For further information contact your local USG Boral office.

EMBODIED ENERGY

As shown in the following table, embodied energy per kg of plasterboard compares favourably with other lining materials:

TABLE 4: EMBODIED ENERGY OF LINING MATERIALS	
MATERIAL	PER* EMBODIED ENERGY (MJ/kg)
Plasterboard	4.4
Fibre cement	4.8
Particleboard	8.0
Plywood	10.4
MDF	11.3
Hardboard	24.2

* PER - Process Energy Requirements.

Source: Building Materials Energy and the Environment, Bill Lawson, The Royal Australian Institute of Architects, 1996.

SAFETY

The following precautions are recommended when installing and finishing plasterboard:

- Avoid creating dust when handling plasterboard or mixing jointing compounds.
- When sanding, minimise the effects of dust by:
 - providing adequate ventilation
 - wearing eye protection
 - wearing a respiratory mask conforming to AS/NZS 1716 *Respiratory protective devices*
 - using mechanical sanding tools fitted with dust extractor and storage bag.
- Keep tools and materials out of reach of children.

In addition, the users should observe Occupational Health and Safety tips contained on the packaging labels for USG Boral products as well as safe manual handling practices.

FIRST AID

- If plaster compound or dust comes into contact with the eyes, wash eyes thoroughly with clean potable water.
- If plaster compound or dust comes into contact with skin, wash skin thoroughly with soap and water.
- If dust is inhaled, move to a fresh air environment.
- If plastering compound or dust is ingested, drink plenty of water.

Material Safety Data Sheets for USG Boral products can be downloaded from www.usgboral.com

In emergencies call **1800 033 011**

For poison assistance call **13 11 26**

DESIGN CONSIDERATIONS

When designing a house, a number of factors need to be considered to ensure satisfactory internal environment and long term performance of plasterboard linings:

CONDENSATION

Condensation occurs when warm and humid air comes into contact with cold surfaces.

Condensation on internal building surfaces is more likely to occur where there are large temperature fluctuations and the moisture content inside a house (often generated in a bathroom, laundry or kitchen) is high.

Repeat or prolonged condensation may lead to; nail-popping, sagging ceiling linings, rotting, mould growth, joint and corner cracking and deterioration of internal air quality. If left untreated, condensation may result in structural damage to the building and health concerns for the building occupants.

The following precautions can help minimise internal condensation:

- Keep air spaces well ventilated to promote moisture dissipation, especially in the roof and sub-floor spaces.
- In rooms such as bathrooms, kitchens and laundries exhaust moisture-laden air to the outside of the building and not into the roof or ceiling space.
- Use vapour barriers in conjunction with insulation around the building envelope. Place vapour barrier on the warm side of insulation.
- Use thermal breaks on steel framing members (refer NCC).

VENTILATION

Roof spaces and building sub-floors should be well ventilated in order to prevent condensation and heat build up (especially in metal framed buildings and dark coloured roofs without sarking).

Refer NCC for minimum ventilation and clearance requirements for sub-floor spaces.

Ample air space is necessary for good ventilation in ceiling areas, particularly below metal decks and tiled roofs with aluminium foil sarking.

USG Boral recommends ventilating unheated roof spaces above ceilings in cold or moderate climates by:

- Using louvres or other ventilation devices (ie Whirlybirds) to cross-ventilate roof spaces.
- Ensuring any attic space suitable for use as a habitable room, or walled-off storage area has at least 50% of the required ventilating area located in the upper part of the ventilated space.
- Restricting the unheated space to as near the high point of the roof as possible and above the anticipated level of any future ceilings.
- Ensuring that the ratio of the total net free ventilating area to ceiling area is not less than 1:150.



Figure 2: House Ventilation Paths

» DESIGN CONSIDERATIONS

DEVICES GENERATING HEAT

USG Boral Plasterboard does not recommend the use of radiant heating systems continuously subjecting plasterboard ceilings to temperatures in excess of 42°C.

Prolonged exposure to temperatures higher than 42°C may cause changes in the chemical composition of the gypsum core and a loss of plasterboard integrity over time.

The following regulatory and normative requirements must be followed in order to prevent plasterboard deterioration due to excessive temperatures from heat generating devices:

- NCC provisions for installation of heating appliances, fireplaces, chimneys and flues
- AS/NZS 2918 *Domestic solid-fuel burning appliances – Installation*
- AS/NZS 5601 *Gas installations*.

In accordance with AS/NZS 5601, gypsum based wall boards within 200mm of the edge of the nearest burner must be protected to a height of not less than 150mm above the periphery of that burner and for the full length of the cooking surface area with a fire resistant facing material.

In no case the periphery of the burner should be closer than 140mm to wall linings.

6mm fibre cement board constitutes an acceptable method of protection for 10mm plasterboard in domestic installations.

13mm FIBEROCK complies with requirements of AS/NZS 5601 for fire resistant materials behind 5mm toughened glass or stainless steel splashbacks in non-load carrying situations.

Refer splashback fire protection requirements by relevant State and Territory authorities.

ROOF SARKING

Roof sarking can reduce the risk of condensation and also provides protection from the elements such as wind, dust and rain.

Sarking is strongly recommended under tiled roofs in order to prevent ceiling damage due to rain blowback.

ACOUSTICS

Effective sound isolation is an essential element of functional house design.

Unwanted noise may emanate from external sources such as traffic or neighbouring properties, or from internal sources such as home entertainment systems or plumbing.

Common design factors that can influence the level of noise within a house include:

- House orientation
- Internal layout
- Location of doors and windows
- Placement of power points, downlights and other services penetrations
- Placement of plumbing and heating/air conditioning services
- Location of appliances and audio visual equipment.

The diagram below shows acoustic performance of some USG Boral wall systems:

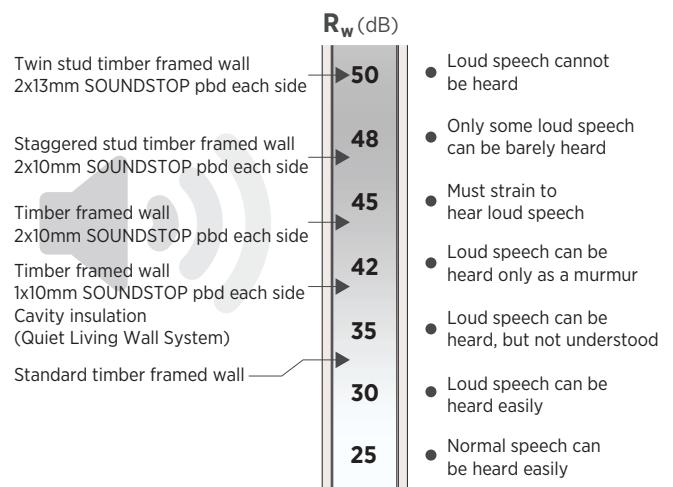

Figure 3: Noise Levels

NOTE:

Acoustic performance of timber or steel framed wall systems can be improved by adding cavity insulation.

» DESIGN CONSIDERATIONS

ATTACHMENTS

A wide range of proprietary fixings are available for attaching light fixtures directly to plasterboard linings. Such fixings should be used in accordance with manufacturers' instructions and should not support loads in excess of maximum allowed.

Heavy loads must be fixed directly into the studs or noggings with appropriate fasteners.

The following point loads can be supported directly by FIBEROCK linings:

FIBEROCK THICKNESS	MAXIMUM POINT LOAD PARALLEL TO THE BOARD*
10mm	10kg
13mm	13kg
16mm	16kg

* Loads applied at the head of a single 8 gauge high thread screw inserted sufficiently to allow the parallel thread section of the screw to be in contact with the full depth of the FIBEROCK lining.

NOTE:

Wall framing must be checked for its capacity to carry attached loads.

WALLS ON BOUNDARY

According to NCC, external walls on or in close proximity to the boundary are required to be fire rated from the outside (refer NCC for fire rating requirements). USG Boral OutRwall® lightweight external wall systems have been specifically designed for this application and are available in fire ratings up to FRL 90/90/90.

For more information refer to www.usgboral.com/au/outrwall

ATTACHED DWELLINGS

Separating walls between attached dwellings must satisfy NCC fire rating and acoustic requirements.

USG Boral Partiwall lightweight separating wall systems have been specifically designed to suit Australian construction methods and are available in fire ratings up to FRL 90/90/90 and acoustic ratings up to $R_w+C_{tr}=57dB$.

For more information refer to www.usgboral.com/au/partiwall

CONTROL JOINTS

Plasterboard linings are not designed to withstand stresses due to structural movements or excessive changes in temperature or humidity.

Potential stress build up and cracking can be minimised by incorporating control joints as follows:

- Provide control joints in walls and ceilings at maximum 12m intervals in both directions (max 6m intervals in external ceilings) and at every change of lining material type (ie gypsum board to fibre cement).
- Provide horizontal control joints at mid-floors in stairwells in multi-storey buildings.
- Place plasterboard control joints over movement joints in the substrate or structural elements and at every change of substrate material.
- Utilise floor to ceiling openings as control joints.
- Fit double studs or joists, spaced slightly apart, in the frame at control joint locations (refer Framed Walls – Control Joints on page 35).
- Control joints should extend through cornice.
- Ceiling battens should be discontinued at control joint locations.
- Control joints can be formed by fitting Rondo P35 Control Joint or plastic expansion beads that leave a neat, clean and flexible joint (see P35 Control Joint installation instructions on page 35).

NOTE:

Proprietary control joint sections are designed to accommodate normal expansion/contraction movements in plasterboard linings and substrates, and not significant structural movements.

Other solutions may be required in such situations.

» DESIGN CONSIDERATIONS

LEVELS OF FINISH

The term 'Level of Finish' applies to plasterboard linings prior to decoration.

AS/NZS 2589 *Gypsum linings — Application and finishing* defines three levels of finish: 3, 4 and 5. Level 4 is the default level of finish for plasterboard linings, unless specified otherwise.

It is essential that the level of finish is determined at the design stage since each level has specific requirements for substrate tolerances and plasterboard installation, jointing and finishing. The desired level of finish may not be achieved unless all of these requirements are met through various stages of construction.

Levels of finish recommended for various lighting conditions and surface decorations are shown in Figure 4.

For the full description of levels of finish and guidelines on assessment of finished surfaces refer AS/NZS 2589. A summary of various levels of finish is provided below:

LEVEL 3

This level of finish is used in areas that do not require decoration or where finish is not important (for example, above ceiling level or inside service shafts and the like).

All joints and interior angles must have tape embedded in the joint compound and one separate coat of joint compound applied over all joints and fastener heads.

Butt joints and recessed joints in walls and ceilings can be on framing members.

LEVEL 4

This is the default and generally accepted level of plasterboard finish. All joints and interior angles must have tape embedded in the jointing compound and a minimum of two separate coats of joint compound applied over all joints, angles, fastener heads and accessories.

Butt joints in walls and ceilings must be between framing members. Wall butt joints longer than 400mm and less than 2m above the floor must be back-blocked. All ceiling butt joints must be back-blocked. Recessed joints in the ceilings must be back-blocked in any area containing three or more recessed joints.

If Level 4 surface is to be exposed to critical light (see Glancing Light on page 13), it should be covered with textured finishes or wall coverings. Smooth textured finishes and flat/matt or low sheen paints can be used when Level 4 finish is illuminated by non-critical lighting. Flat paints in this situation tend to conceal joints better.

Weight, texture and sheen level of wall coverings and finishes should be carefully evaluated and joints should be adequately concealed if wall-covering material is lightweight, glossy or lightly patterned.

NOTES:

- In critical lighting conditions, surface variations may still be apparent in a Level 4 surface finish.
- Gloss, semi-gloss or deep tone paints are not recommended for Level 4 finish, as they accentuate surface variations.

LEVEL 5

Level 5 finish should be used where gloss or semi-gloss paints are specified or where lining surfaces will be exposed to critical lighting conditions.

Level 5 finish is characterised by a parity of surface texture and porosity. All joints and interior angles must have tape embedded in the jointing compound and a minimum of two separate coats of jointing compound applied over all joints, angles, fastener heads and accessories.

Butt joints in walls and ceilings must be between framing members and back-blocked. Recessed joints in the ceilings must be back-blocked.

The work is finished with proprietary surface preparations or skim coating to remove differential surface textures and porosity. A suitable paint or plaster material (eg SHEETROCK Tuff-Hide primer surfacer or DIAMOND® Veneer Finish) is sprayed, rolled or trowelled over the defined area. The surface texture must be random and monolithic, concealing joints and fixing points.

NOTES:

- If Level 5 finish is desired for a decorated plasterboard surface, this must be specified at the design stage.
- Level 5 finish is difficult to achieve and always requires the cooperation of the framer, plasterer and painter in establishing suitable work practices that deliver the agreed painted finish for the given project.
- Some minor surface variations may still be visible in Level 5 finish, however, these will be minimised.
- The surface of the defined area may require sanding to be suitable for decoration.

» DESIGN CONSIDERATIONS

TABLE 6: LEVELS OF FINISH REQUIREMENTS SUMMARY

LEVEL OF FINISH	BUTT JOINTS LOCATION		CEILING BUTT JOINTS BACK-BLOCKING	CEILING RECESSED JOINTS BACK-BLOCKING		FRAMING TOLERANCES* (mm)		JOINTING SYSTEM
	ON FRAMING MEMBERS	BETWEEN FRAMING MEMBERS		LESS THAN 3 RECESSED JOINTS IN A ROOM	3 OR MORE RECESSED JOINTS IN A ROOM	90% OF AREA	REMAINING AREA	
3	Allowed	Optional	Optional	Optional	Optional	4	5	Tape Coat + 2nd Coat
4	Not Allowed	Must	Must	Optional	Must**	4	5	Tape Coat + 2nd Coat + Finishing Coat
5	Not Allowed	Must	Must	Must	Must	3	4	Tape Coat + 2nd Coat + Finishing Coat + Skim Coat over whole face

* Maximum deviation at any point of the bearing surface of the finished framing prior to installation of plasterboard linings, when measured with 1.8m straight edge (refer AS/NZS 2589).

** Level 4 ceilings supported by a ceiling suspension system in accordance with AS/NZS 2785 do not require back-blocking of recessed joints provided there is not rigid connection between ceiling and wall.

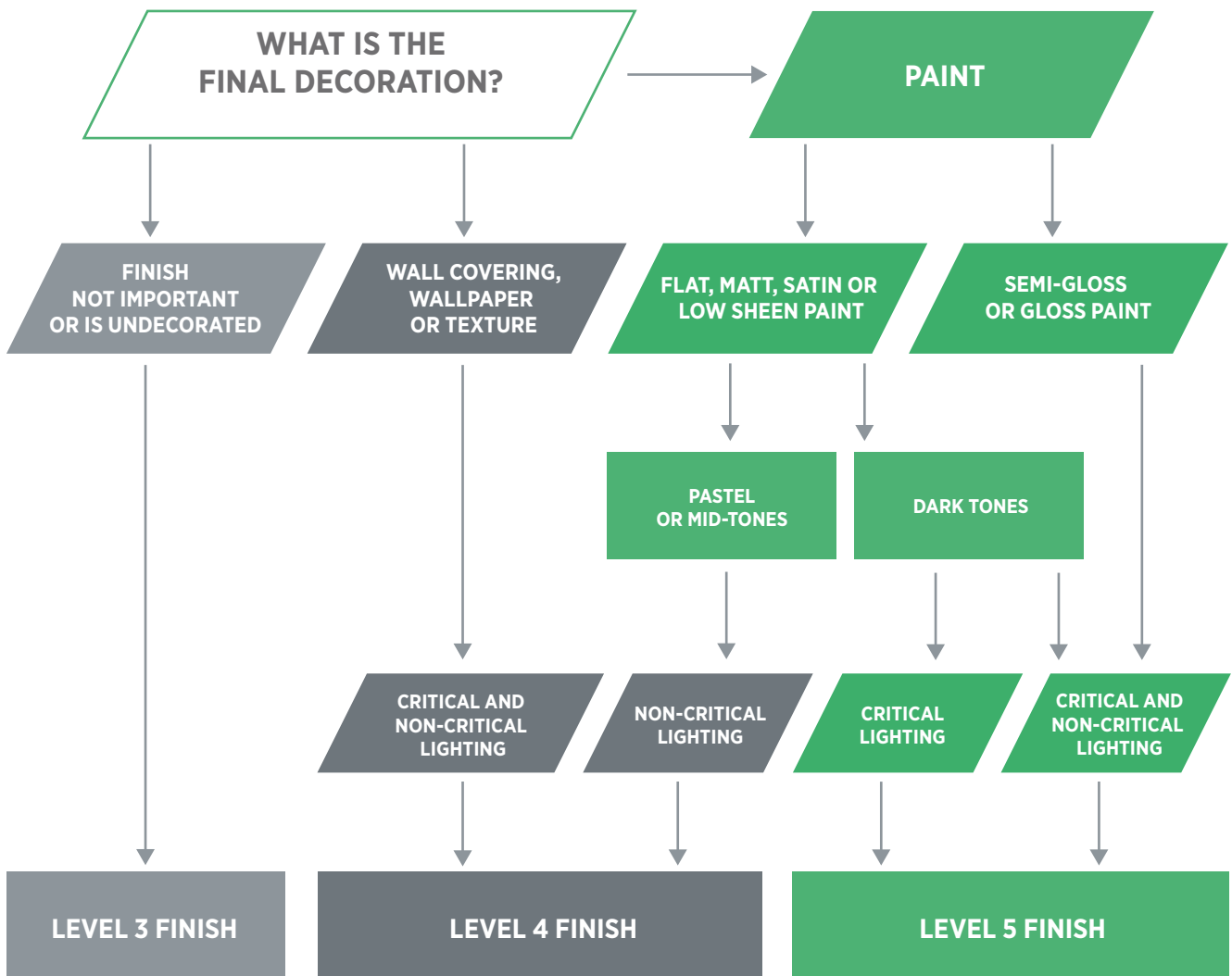

Figure 4: Levels of Finish

» DESIGN CONSIDERATIONS

GLANCING LIGHT

Glancing light is the light that shines across a surface rather than directly at it. Glancing light casts shadows from minute undulations that would not normally be visible in diffuse (non-directional) lighting.

While minor surface variations can always be expected (even with a Level 5 finish) the appearance of flatness will depend predominantly on the amount of glancing light the surface receives and to some degree its intensity and direction.

Some of the worst instances of glancing light occur with ceiling-mounted unshaded light globes and where windows are located close to ceilings or walls allowing sunlight to shine across adjacent surfaces.

In order to avoid the effects of glancing light, it is important to carefully plan selection and placement of windows and lighting during the design phase.

ARTIFICIAL LIGHT

It is recommended that artificial lighting should either be hung below the ceiling surface and fitted with shades, or recessed into the ceiling (ie downlights).

Positioning of feature lighting, such as spot and flood lights needs to be planned so that light shining across wall or ceiling surfaces is minimised.

Wall mounted lights, shining up on the ceiling, tend to accentuate wall surface variations.

High output lights are more severe in their effect because they create deeper shadows. Similarly, the whiter the light, the stronger the contrast and the greater the perceived surface variations.

Soft, low wattage, diffused lighting provides the most favourable lighting conditions for wall and ceiling surfaces.



Figure 5: **Plasterboard surface under normal lighting conditions**

NATURAL LIGHT

The effects of natural glancing light can be exaggerated by late afternoon or early morning sunlight as well as reflections from adjacent walls, roofs and water features such as swimming pools, canals and waterways.

Wall surfaces abutting tall, narrow windows facing the sun (or a reflecting surface) are likely to be affected, as will raked ceilings abutting clerestory windows and flat ceilings abutting window heads.

Where a building design cannot be changed, the effects of glancing light can be minimised by using window shades, soft furnishings, curtains, blinds and pelmets.

Avoid using dark, high-gloss paint finishes as they highlight glancing light problems; instead, use light, matt finishes to minimise the effect.

NOTES:

- USG Boral publication *Guide to Lighting and Decoration of Plasterboard* provides further guidance to good lighting and decoration practice.
- High intensity halogen floodlights or fluorescent lights should not be used for visual inspection of interior surfaces as they create unfavourable glancing light conditions.

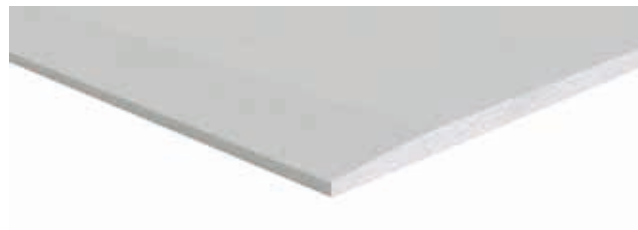

Figure 6: **Same plasterboard surface under glancing light**

LINING MATERIALS

PLASTERBOARD

The following USG Boral plasterboard products are commonly used in residential construction:



10mm SHEETROCK Wall Board

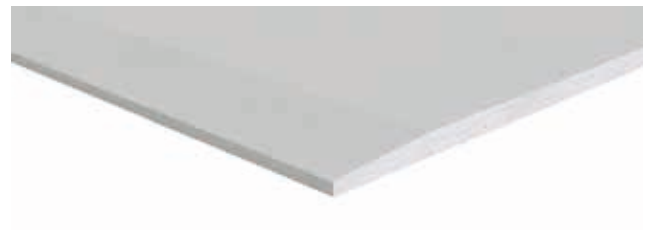

10mm SHEETROCK Ceiling Board

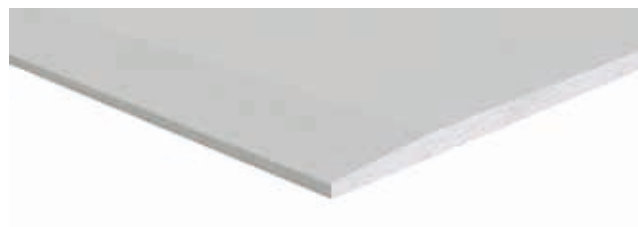

13mm SHEETROCK Standard

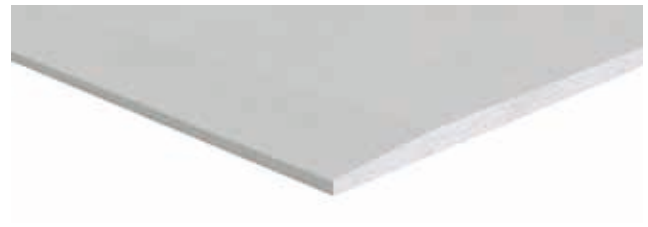

10mm UNISPAN

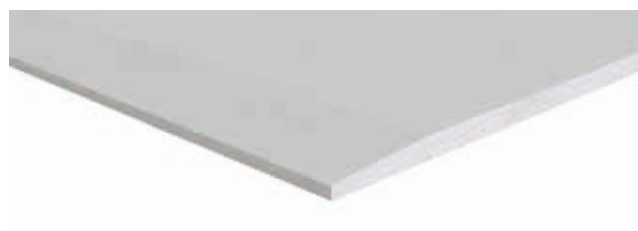

10mm/13mm STANDARD

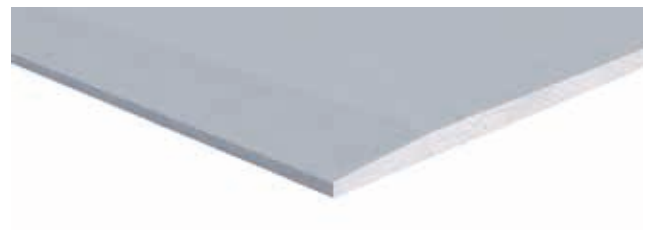

10mm/13mm WETSTOP



13mm FIBEROCK



10mm/13mm SOUNDSTOP

Figure 7: **USG Boral Plasterboards**

» LINING MATERIALS

PLASTERBOARD SIZES

Standard sizes of select USG Boral plasterboard products are shown in the following table:

TABLE 7: SIZE AND AVAILABILITY OF PLASTERBOARD													
PLASTERBOARD TYPE	EDGE PROFILE	THICKNESS (mm)	WIDTH (mm)	LENGTH (mm)									MASS. (kg/m ²)
				2100	2400	2700	3000	3600	4200	4800	5400	6000	
SHEETROCK Wall Board	RE	10	1200		●	●	●	●	●	●		●	5.4
			1350				●	●	●			●	
SHEETROCK Standard	RE	13	1200			●	●	●			●	●	7.2
			1350					●			●		
SHEETROCK Standard	RE/SE	13	1350								●		
	SHEETROCK Ceiling Board	RE	10	1200		●	●	●	●	●	●		●
1350							●	●	●	●		●	
RE/SE		10	1200									●	
			1350									●	
UNISPAN	RE	10	1200		●	●	●	●	●	●		●	7.2
			1350				●	●	●	●		●	
	RE/SE	10	1200									●	
			1350									●	
FLEXIBOARD	RE	6.5	1200					●				4.1	
SOUNDSTOP	RE	10	1200					●			●		9.0
			1350								●		
		13	1200				●	●					11.8
			1350					●					
STANDARD	RE	10	1200		●	●	●	●	●	●		●	6.8
			1350				●	●	●	●		●	
		13	900			●							
			1200		●	●	●	●	●	●		●	8.6
	1350					●	●	●	●				
		SE	10	900	●	●	●						6.8
	1200			●	●	●							
	RE/SE	13	1375					●				8.6	
WETSTOP	RE	10	1200		●	●	●	●	●			●	7.4
			1350					●			●		
	13	1200			●	●	●					9.4	
FIBEROCK	SE	10	1200			●	●						9.5
	RE	13	1200				●						12.0
		16	1200				●						15.0

LEGEND:

RE - Recessed Edge, SE - Square Edge, RE/SE - Recessed Edge/Square Edge

NOTES:

- Plasterboard sizes and weights are correct at the time of publication and are subject to change.
- For availability of plasterboard sizes in various regions please contact local USG Boral outlet or distributor.
- For the full range of USG Boral plasterboard products see usgboral.com

» LINING MATERIALS

MATERIAL QUANTITIES

Plasterboard coverage areas and approximate fixing and jointing requirements are given in the following tables:

TABLE 8: FIXING AND JOINTING COMPOUNDS PER 100m ² of PLASTERBOARD				
FRAME SPACING	WALLS		CEILINGS	
	600mm	450mm	600mm	450mm
FIXING METHOD				
Nails only	1250	1490	N/A	N/A
Nails and Adhesives	840	870	N/A	N/A
	2.9kg stud adhesive	4.3kg stud adhesive		
Screws only	910	1050	1010	1210
Screws and Adhesives	700	750	800*	900*
	2.9kg stud adhesive	4.3kg stud adhesive	2.9kg stud adhesive	4.3kg stud adhesive
JOINTING MATERIALS**				
Tape	75m			
Base Compounds (1st and 2nd coats incl angles)	16kg to 22kg			
Finishing Compounds (Finishing coat only)	8kg to 10kg			

* Conventional fixing method

** Based on horizontal sheeting. The coverage rates are approximate and should be used as a guide only. The figures may vary significantly due to onsite practices and environmental factors.

TABLE 9: BOARD COVERAGE AREA m ²																
WIDTH mm	LENGTH mm	NUMBER OF SHEETS														
		1	2	3	4	5	6	7	8	9	10	20	30	40	50	60
1200	2400	2.88	5.76	8.64	11.52	14.40	17.28	20.16	23.04	25.92	28.80	57.60	86.40	115.20	144.00	172.80
	2700	3.24	6.48	9.72	12.96	16.20	19.44	22.68	25.92	29.16	32.40	64.80	97.20	129.60	162.00	194.40
	3000	3.60	7.20	10.80	14.40	18.00	21.60	25.20	28.80	32.40	36.00	72.00	108.00	144.00	180.00	216.00
	3600	4.32	8.64	12.96	17.28	21.60	25.92	30.24	34.56	38.88	43.20	86.40	129.60	172.80	216.00	259.20
	4200	5.04	10.08	15.12	20.16	25.20	30.24	35.28	40.32	45.36	50.40	100.80	151.20	201.60	252.00	302.40
	4800	5.76	11.52	17.28	23.04	28.80	34.56	40.32	46.08	51.84	57.60	115.20	172.80	230.40	288.00	345.60
	5400	6.48	12.96	19.44	25.92	32.40	38.88	45.36	51.84	58.32	64.80	129.60	194.40	259.20	324.00	388.80
	6000	7.20	14.40	21.60	28.80	36.00	43.20	50.40	57.60	64.80	72.00	144.00	216.00	288.00	360.00	432.00
1350	2400	3.24	6.48	9.72	12.96	16.20	19.44	22.68	25.92	29.16	32.40	64.80	97.20	129.60	162.00	194.40
	2700	3.65	7.29	10.94	14.58	18.23	21.87	25.52	29.16	32.81	36.45	72.90	109.35	145.80	182.25	218.70
	3000	4.05	8.10	12.15	16.20	20.25	24.30	28.35	32.40	36.45	40.50	81.00	121.50	162.00	202.50	243.00
	3600	4.86	9.72	14.58	19.44	24.30	29.16	34.02	38.88	43.74	48.60	97.20	145.80	194.40	243.00	291.60
	4200	5.67	11.34	17.01	22.68	28.35	34.02	39.69	45.36	51.03	56.70	113.40	170.10	226.80	283.50	340.20
	4800	6.48	12.96	19.44	25.92	32.40	38.88	45.36	51.84	58.32	64.80	129.60	194.40	259.20	324.00	388.80
	5400	7.29	14.58	21.87	29.16	36.45	43.74	51.03	58.32	65.61	72.90	145.80	218.70	291.60	364.50	437.40
	6000	8.10	16.20	24.30	32.40	40.50	48.60	56.70	64.80	72.90	81.00	162.00	243.00	324.00	405.00	486.00

» LINING MATERIALS

DELIVERY, HANDLING AND STORAGE

To reduce the risk of damage, plasterboard should be delivered to site just prior to installation.

During handling, sheets should be carried in an 'upright' position with particular care taken to protect the edges.

Plasterboard should be stored in neat, flat stacks off the ground/floor in a dry covered area. This will prevent sagging and minimise damage to board edges and surfaces.

If storing outdoors, stack sheets on a level, moisture-free platform, and keep fully protected from the weather. Ensure the platform can support a load up to 800kg/m³ density.

Plasterboard stacking supports should be spaced at no more than 600mm centres (400mm centres for 6.5mm Flexiboard).

Refer also to GBMA Guide to Safe Site Delivery of Plasterboard and Associated Products.

HOW TO POSITION A LOAD

- Billet width and height should be uniform
- Billet length should correspond to plasterboard width, eg.
 - 1200mm long billets for 1200mm wide plasterboard
 - 1350mm long billets for 1350mm wide plasterboard.

PLACING BILLETS

All billets are to be placed in proper vertical alignment so each tier is evenly supported. If billets are not spaced evenly or in vertical alignment, cumulative pressure on unsupported lower units may cause plasterboard to sag.



Figure 8: **Correct placement of billets**

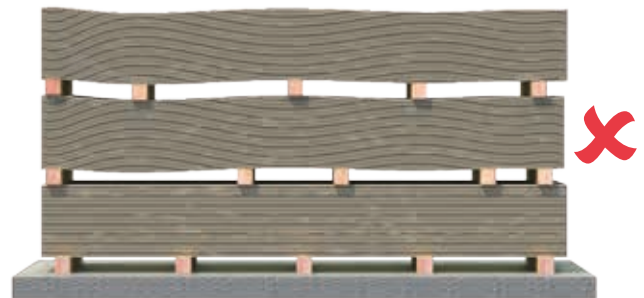

Figure 9: **Incorrect placement of billets**



Figure 10: **How to position a load**

FRAMING

FRAMING CHECK

Prior to installation of plasterboard, framing should be thoroughly checked by builder to ensure that:

- It is plumb, level and square.
- Spacing of studs, joists and battens does not exceed the limits specified in the relevant sections of this Manual.
- Maximum deviations in the bearing surface of the finished framing do not exceed the maximum tolerances allowed for the required Level of Finish (refer Table 6 Framing Tolerances). Where these tolerances are exceeded, a suitable levelling system should be used.
- Noggings supporting services such as taps and cisterns do not protrude beyond the face of the framing.
- All openings are framed and ceiling perimeter battens are installed where required.
- Trimmers are installed where primary ceiling support members such as girders, trusses and joists, change direction within a room or where required to support ceiling loads.
- All contact surfaces are dry, clean and free from foreign materials such as oil, grease and dirt.
- Plumbing and electrical services have been installed and do not protrude beyond the face of the framing.
- The area is weatherproof.

FIXING FACE REQUIREMENTS

Minimum widths of framing member fixing faces are as follows:

TABLE 10: MINIMUM WIDTHS OF FIXING FACES (mm)		
FIXING FACE TYPE	TIMBER FRAMING	STEEL FRAMING
Supporting a joint	35	32
Other	30	30

Plasterboard can be installed directly over existing linings if they are firm, sound and sufficiently flat for the required level of finish (ensure fasteners are of sufficient length by allowing for the thickness of existing linings).

TIMBER FRAMING

Timber framing substrates for plasterboard linings must comply with AS 1684 *Timber Framed Construction*. Roof trusses must comply with AS 4440 *Installation of Nailplated Timber Roof Trusses*.

For the purposes of determining a suitable plasterboard fixing method, timber falls into the following categories:

LOW SHRINKAGE TIMBER

- Timber with a moisture content under 16% at the time of lining. Generally includes seasoned or kiln dried timbers such as F5/F7 Radiata Pine.
- Timber with moisture content at or above 16% but a tangential shrinkage below 8%. Generally includes green timbers such as Radiata Pine, Hoop Pine, Douglas Fir, Cypress Pine, Western Hemlock, Jarrah, Red Narrow-leaved Ironbark, Rose/Flooded Gum and Spotted Gum.

Both mechanical fastener only or combination adhesive/fastener fixing methods can be used for low shrinkage timbers.

HIGH SHRINKAGE TIMBER

Timber with moisture content at or above 16% at the time of lining and a tangential shrinkage of more than 8% is categorised as high shrinkage timber. This generally includes timbers such as Mountain Ash, Messmate, River Red Gum, Alpine Ash, Karri and Blackbutt (commonly referred to as Builder's, or OB, Hardwood).

When fixing plasterboard to high shrinkage timbers, a combination adhesive/fastener system must be used.

TREATED TIMBER

USG Boral PremiumBond™ stud adhesive can be used with anti-termite treated or untreated internal timber. H2F treated timber should be aired for a minimum of 14 days prior to application of stud adhesive.

STEEL FRAMING

Steel framed plasterboard substrates must comply with AS/NZS 4600 *Cold-formed steel structures*, National Association of Steel-framed Housing (NASH) *Standard for Residential and low-rise steel framing* and AS 1397 *Steel Sheet and Strip – hot dipped, zinc coated or aluminium/zinc coated*.

The framing must be assembled and installed in accordance with the manufacturer's instructions.

LININGS LAYOUT

- Carefully plan installation. Sheets should be set out to ensure best coverage and to minimise butt joints and waste.
- Wall sheets should be applied horizontally if a level of finish of 4 or 5 is required. Sheeting may be vertical if it covers the whole wall.
- Where possible, sheets should run across doors and windows and be cut out after fixing. The cut-outs can be used to cover small areas.
- Full length sheets should be used where possible to eliminate the need for sheet-end butt joints.
- Where sheet-end butt joints are necessary, they must be positioned between framing members.
- Stagger butt joints on adjoining sheets and with those on opposite sides of the wall.
- Vertical joints should be kept a minimum of 200mm from the edge of openings.
- Ceiling sheets should be installed with the long edge at right angles to the direction of the support members.
- Provide control joints in walls and ceilings (refer Control Joints on pages 10 and 35).

NOTES:

- Horizontal fixing is the preferred wall sheet orientation for a Level 4 finish as it minimises the effects of glancing light, reduces jointing and places joints at a convenient height for stopping.
- Noggings should not be positioned behind recessed joints in horizontal applications.
- The use of panel lifters will assist in placement and fixing of ceiling sheets.

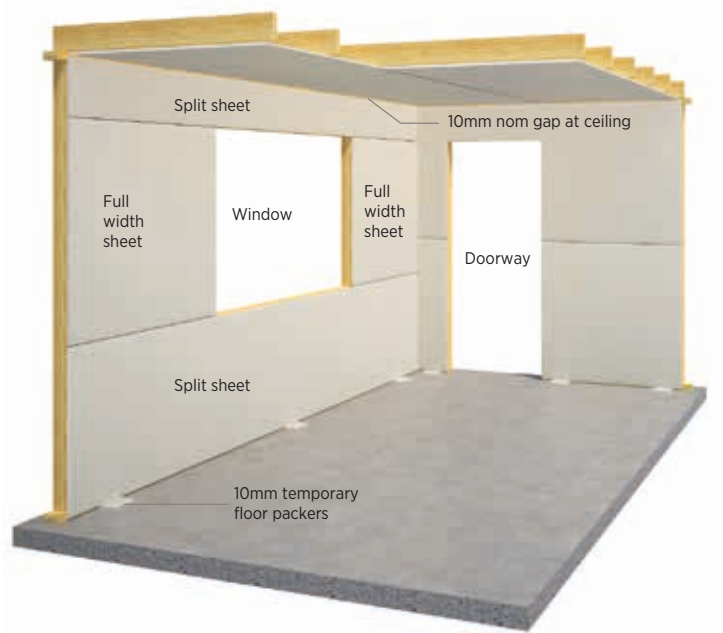

Figure 12: Room Layout Option 1

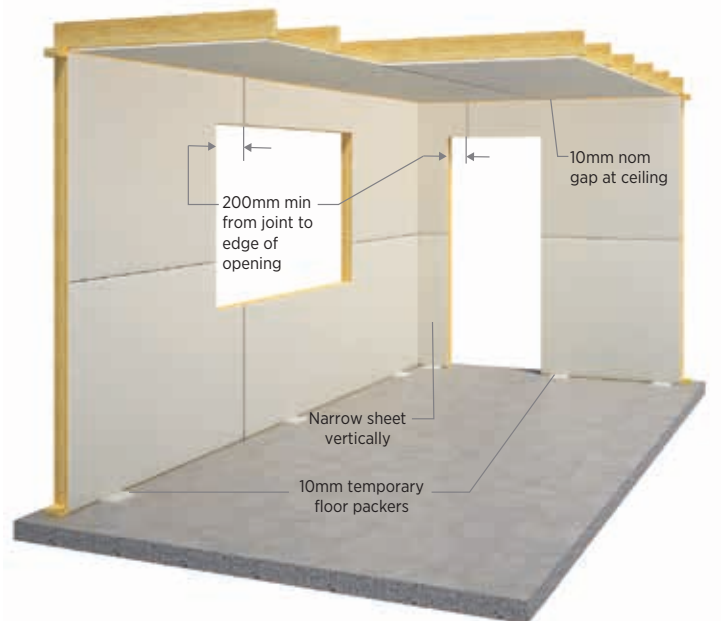

Figure 13: Room Layout Option 2

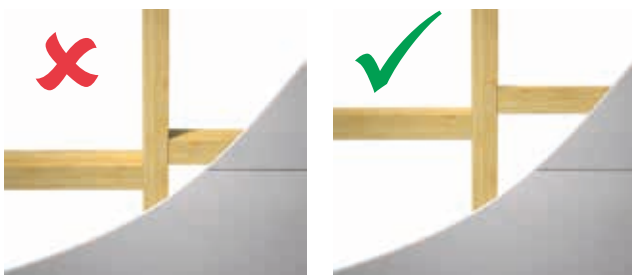

Figure 11: Offset Noggings Behind Recessed Joints

PLASTERBOARD FIXING

Plasterboard should preferably be applied to ceilings first and then to walls. This will minimise sheet handling and damage.

FASTENING SYSTEMS

Plasterboard should be fixed to framing using one of the following fastening systems:

- Combination of adhesive and fasteners
- Screw fixed only
- Nail fixed only.

NOTES:

- The combination adhesive and fastener system is the preferred option for general applications.
- Combination adhesive and fastener system must be used on High Shrinkage timbers (refer page 18).
- Use a fastener-only system on walls that are to be tiled or that may carry surface-mounted items such as mirrors – do not use adhesive.
- Fastener-only system must be used for fixing of FIBEROCK linings.
- Stud adhesive does not constitute a fixing system on its own and must be used in conjunction with screws or nails.
- Avoid fixing plasterboard linings before the installation of ridge capping and the enclosure of gable ends.





GENERAL SCREW AND NAIL FIXING

- Plasterboard sheets must be held firm against framing while driving fasteners.
- Fixing of the board to commence from centre out.
- Screws and nails should be slightly overdriven to allow for stopping but should not break the face paper.
- Screws and nails should be positioned 10–16mm from sheet edges and ends.
- Screws should be selected from Tables 11 and 12.
- Nails should be selected from Tables 13 and 14.
- Screws used for plasterboard fixing must comply with AS 3566 *Self-drilling screws for the building and construction industries. Part 2: Corrosion resistance requirements.*

PLASTERBOARD FASTENERS

SCREWS

TABLE 11: PLASTERBOARD SCREWS

SCREW TYPE	APPLICATION
W 	Wood/timber only
S 	Steel BMT* up to 0.75mm
D 	Steel BMT* 0.80 - 2.00mm
L 	Plasterboard laminating

* BMT - Base Metal Thickness

TABLE 12: SCREW LENGTH (mm)

PLASTERBOARD LINING	TIMBER		STEEL	
	WALLS	CEILINGS	WALLS	CEILINGS
1x10mm	25	30	25	25
1x13mm	30	30	25	25
2x10mm	40	40	30	30
2x13mm	50	50	40	40

* Min 30mm W screws must be used for ceilings direct fixed to timber framing

NAILS

TABLE 13: PLASTERBOARD NAILS

NAIL TYPE	APPLICATION*
Gold Passivated LH Smooth Shank 	Softwood Wall framing
Gold Passivated LH Ring Shank 	Softwood Wall framing
Galvanised LH Smooth Shank 	Hardwood Wall framing
Galvanised LH Ring Shank 	Softwood Wall framing

* USG Boral does not recommend nail fixing of ceiling linings

TABLE 14: NAIL LENGTH (mm)

PLASTERBOARD LINING	SMOOTH SHANKED NAILS		ANNULAR RING SHANKED NAILS	
	SOFTWOOD	HARDWOOD	SOFTWOOD	HARDWOOD
1x10mm	40	30	30	-
1x13mm	40	30	30	-
2x10mm	50	50	-	-
2x13mm	65	50	-	-

INTERNAL CEILINGS

CEILING LOADS AND SPANS

Plasterboard spans and loads directly supported on ceiling linings must not exceed the maximum values indicated in the following table:

TABLE 15: MAXIMUM LOADS AND SPANS FOR INTERNAL CEILINGS					
PLASTERBOARD TYPE	SPAN (mm)	MAXIMUM TOTAL LOAD* FOR GIVEN WIND CLASS (kg/m ²)			
		N1	N2	N3	N4
10mm SHEETROCK Ceiling Board 13mm SHEETROCK Standard	600 (max)	2.6**	2.6**	2.0	2.0
	450	2.6**			
10mm UNISPAN 13mm STANDARD	600 (max)	2.0			
	450	2.6**			
13mm WETSTOP 13mm SOUNDSTOP	600 (max)	2.0			
10mm SHEETROCK Wall Board 10mm STANDARD 10mm WETSTOP 10mm SOUNDSTOP	450 (max)	2.0			

* Total Load includes weight of insulation and any fixtures directly supported on ceiling linings.

** 1/3 Fixing method **must** be used if directly supported load exceeds 2.0kg/m² (maximum load 2.6kg/m²).

NOTES:

- Loads in excess of the above must be supported independently from a roof or ceiling structure.
- Roof / ceiling framing must be checked for its capacity to carry supported loads.

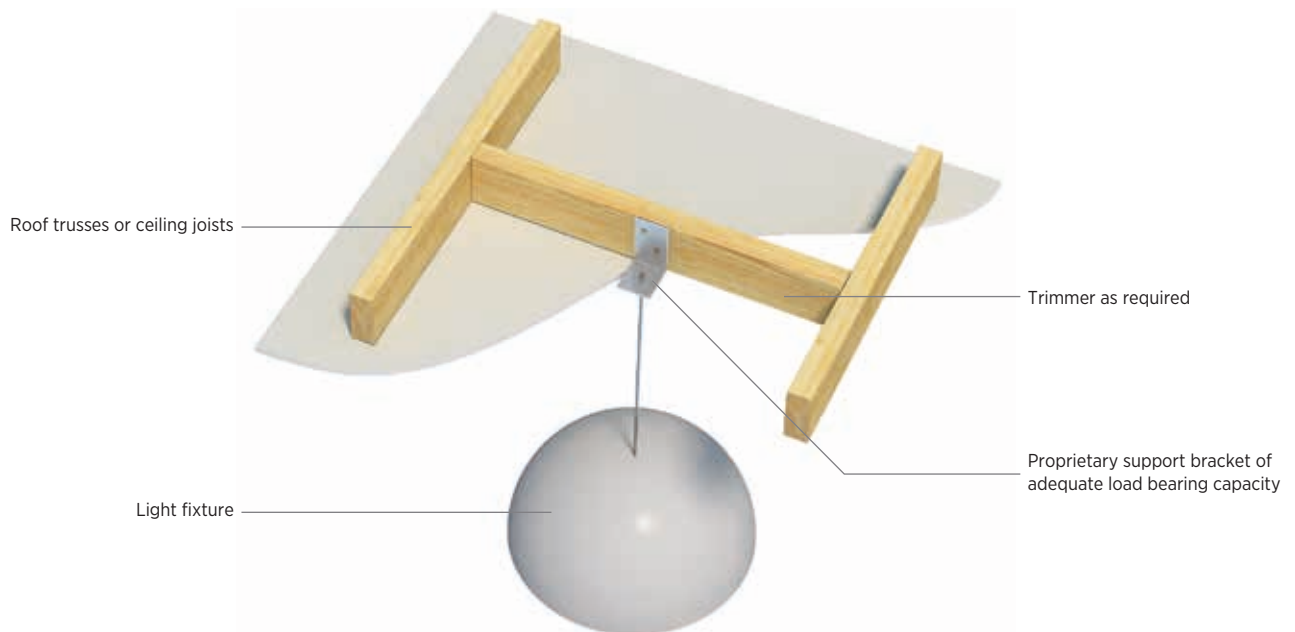

Figure 14: Independent Light Fixture Support

» INTERNAL CEILINGS

CEILING SUPPORT OPTIONS

There are two general support options for ceiling linings:

1. Direct fixed, where sheets are fixed directly to structural ceiling members. If plasterboard is direct fixed to structural ceiling members, trimmers are to be installed by the builder where primary ceiling support members such as girder trusses and joists change direction within a room.
2. Furred or battened fixing, where sheets are fixed to secondary framing members, such as metal or timber battens or metal furring channels installed in the opposite direction to structural members.

NOTES:

- Experience has shown that metal battens or furring channels will generally produce a superior ceiling and it is the recommended method for use under trussed roofs and for ceilings with square set finish.
- Ceiling battens and furring channels should stop at least 10mm clear of non-load bearing internal walls as not to impede truss or floor joist deflection.
- End-to-end joints in Rondo furring channels and 301 batten should be made using appropriate Rondo joiners. Leave 5-10mm gap between joined sections. Stagger adjacent end-to-end joints between different framing members.

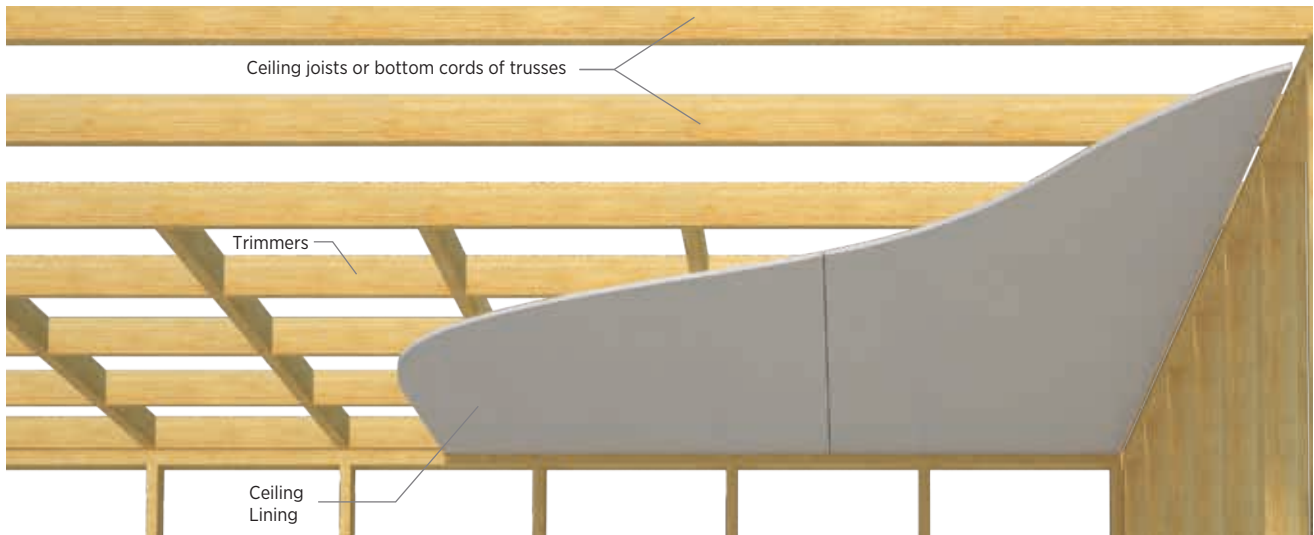

Figure 15: Direct Fixed Ceiling

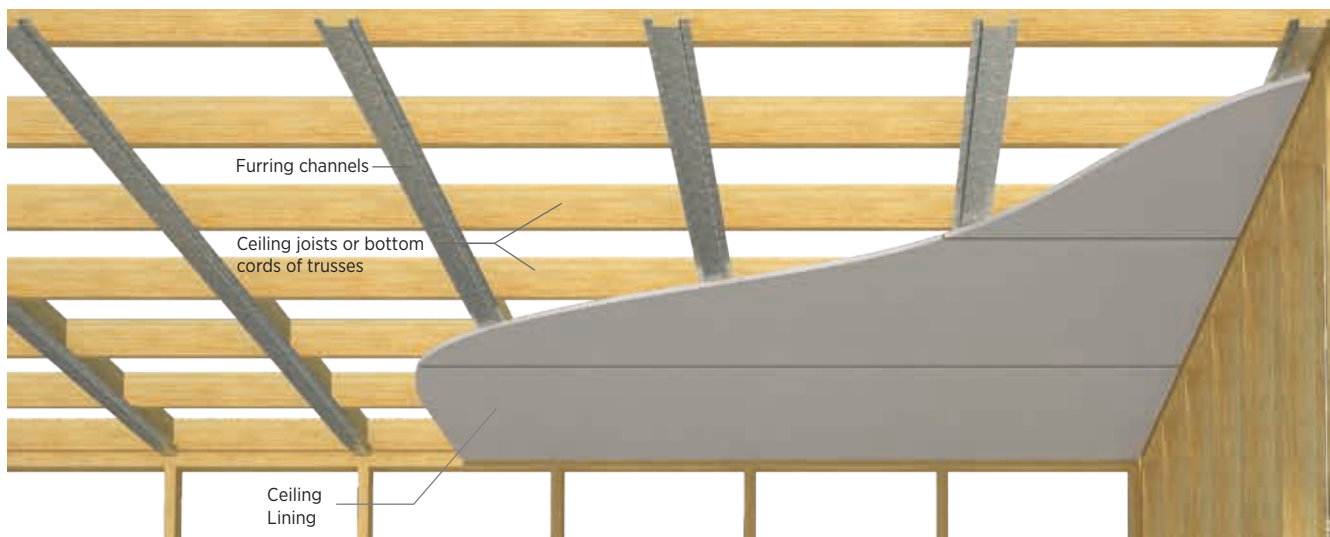

Figure 16: Furred Ceiling

» INTERNAL CEILINGS

METAL FURRING CHANNELS AND BATTENS

USG Boral recommends the following Rondo metal components for furred plasterboard ceilings:

Maximum spans of direct fixed, continuous Rondo furring channels and battens are as follows:



129 Furring Channel

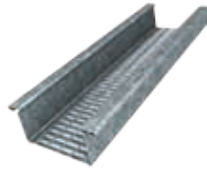

308 Furring Channel

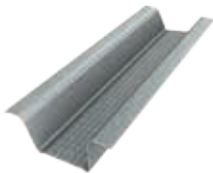

303 Cyclonic Batten

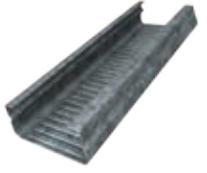

301 Batten



226 Fixing Clip
(for fixing of 129 and 308 Furring Channels)



394 Fixing Clip
(for fixing of 129 and 308 Furring Channels)



304 Fixing Clip
(for fixing of 301 Batten)



314 Fixing Clip
(for fixing of 301 Batten)

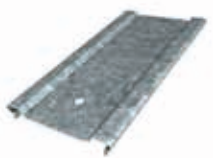

138 Joiner
(for 129 and 308 Furring Channels)



315 Joiner
(for 301 Battens)

TABLE 16: MAX SPANS OF CONTINUOUS 129 FURRING CHANNEL (mm)				
CEILING LINING	WIND CLASS N2		WIND CLASS N3	
	@ 450mm	@ 600mm	@ 450mm	@ 600mm
1x10mm pbd	2070	1900	1850	1630
1x13mm pbd	2060	1850	1810	1600
2x10mm pbd	1680	1530	1680	1525
2x13mm pbd	1650	1530	1650	1470

Source: Rondo Building Services

TABLE 17: MAX SPANS OF CONTINUOUS 308 FURRING CHANNEL (mm)				
CEILING LINING	WIND CLASS N2		WIND CLASS N3	
	@ 450mm	@ 600mm	@ 450mm	@ 600mm
1x10mm pbd	1340	1230	1270	1110
1x13mm pbd	1430	1270	1240	1090
2x10mm pbd	1080	990	1080	990
2x13mm pbd	1150	1080	1150	1000

Source: Rondo Building Services

TABLE 18: MAX SPANS OF CONTINUOUS 303 CYCLONIC BATTEN (mm)				
CEILING LINING	WIND CLASS N2		WIND CLASS N3	
	@ 450mm	@ 600mm	@ 450mm	@ 600mm
1x10mm pbd	1300	1200	1175	1084
1x13mm pbd	1267	1168	1154	1064
2x10mm pbd	1231	1118	1231	1118
2x13mm pbd	1179	1087	1093	1009

Source: Rondo Building Services

TABLE 19: MAX SPANS OF CONTINUOUS 301 BATTEN (mm)				
CEILING LINING	WIND CLASS N2		WIND CLASS N3	
	@ 450mm	@ 600mm	@ 450mm	@ 600mm
1x10mm pbd	1200	1200	1200	1120
1x13mm pbd	1200	1200	1200	1100
2x10mm pbd	861	782	861	782

Source: Rondo Building Services

Figure 17: Rondo Ceiling Components

» INTERNAL CEILINGS

CONTROL JOINTS

Refer Control Joints on page 10 for guidance on control joint locations and construction.

FIXING TO CEILINGS

FIXING WITH COMBINATION OF ADHESIVE AND SCREW FASTENERS

General Fixing Notes

- Framing members should be clean and free from dust, dirt, grease and surface moisture.
- Refer to *General Screw and Nail Fixing* on page 20.
- Stud adhesive daubs should be approx 25mm diameter x 15mm high.
- Do not use adhesive at sheet ends.
- Keep daubs 200mm (nom) from sheet edges.
- Keep daubs 200mm (nom) from screw points.
- It is recommended that at sheet ends screws are spaced at 300mm maximum centres for cornices and 150mm maximum centres for square set finish.

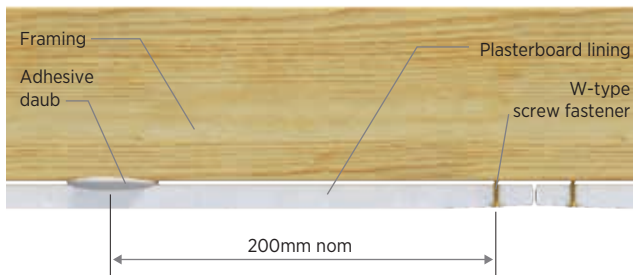

Figure 18: Adhesives and screw fasteners at sheet edges

ADHESIVE AND FASTENER LAYOUT

1/3 Fixing Method (Preferred)

Space fasteners at 1/3 points across the width of the sheet and daubs half way between fasteners.

Conventional Method

Use double fasteners 50-75mm apart along the sheet centreline and space daubs between the fasteners at 230mm maximum centres.

Ceiling fastener and adhesive layouts for both methods are shown in the table below.

SHEET WIDTH	CONVENTIONAL FIXING	1/3 FIXING
900mm	FAF/FAF	FAFAF
1200mm	FAAF/FAAF	FAFAFAF
1350mm	FAAF/FAAF	FAFAFAF

Legend: F = screw F/F = double screws A = adhesive

NOTES:

- 1/3 fixing must be used for ceiling linings applied to H2F treated timber or to painted metal battens.
- USG Boral plasterboard has lines printed on the face of the sheet to guide fixing.
- When using conventional method, temporary fasteners (nails or screws driven through plasterboard blocks to hold sheets in place while adhesive cures) should be installed at every second framing member and remain for at least 24 hours.

FIXING WITH SCREWS ONLY

- Space screws at maximum 300mm centres across the width of the sheet.
- At sheet ends space screws at 300mm maximum centres for cornices and 150mm maximum centres for square set finish.
- Refer to *General Screw and Nail Fixing* on page 20.
- Refer Table 21 and Figure 21 for the number of screwing points across the sheet width.

SHEET WIDTH	SCREW POINTS
900mm	4
1200mm	5
1350mm	6

Note: Screw points should be equally spaced

» INTERNAL CEILINGS

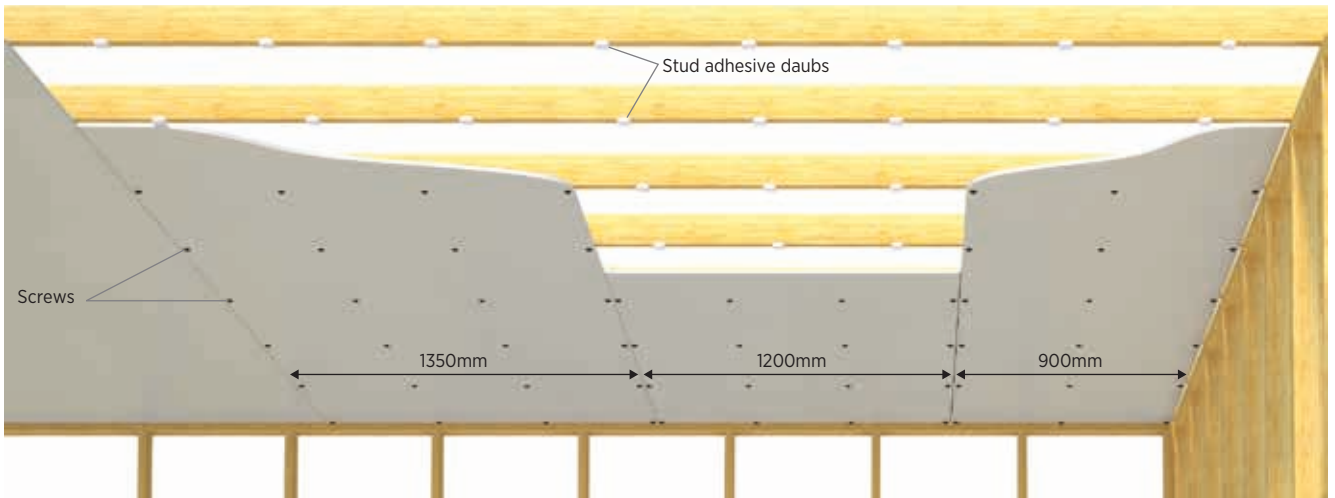

Figure 19: **Combination adhesive and screw fixing to ceilings - 1/3 fixing method**

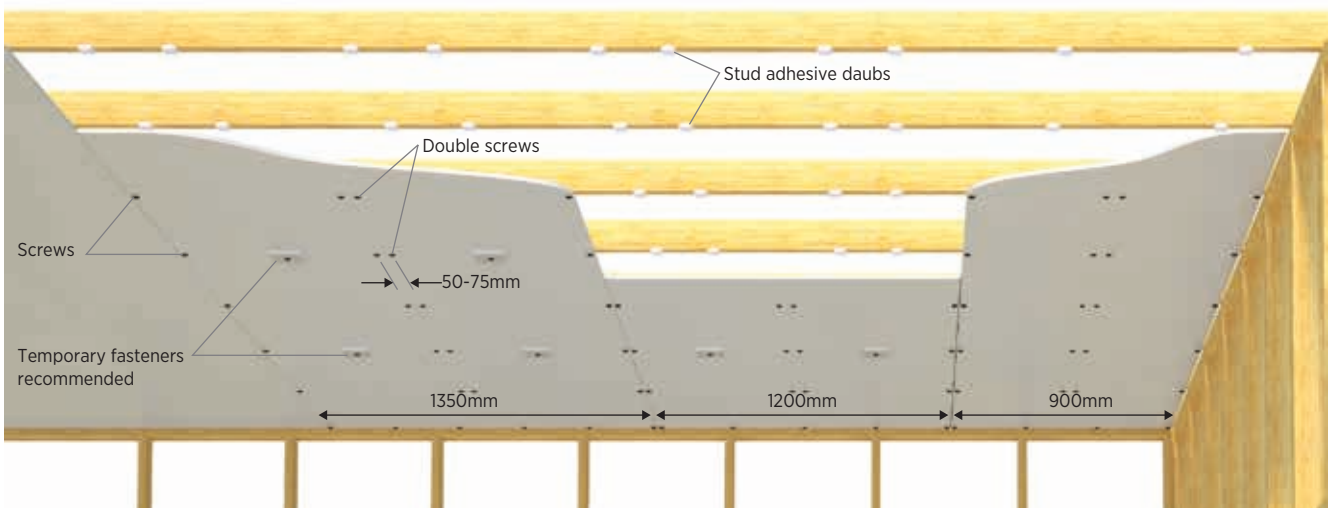

Figure 20: **Combination adhesive and screw fixing to ceilings - conventional method**

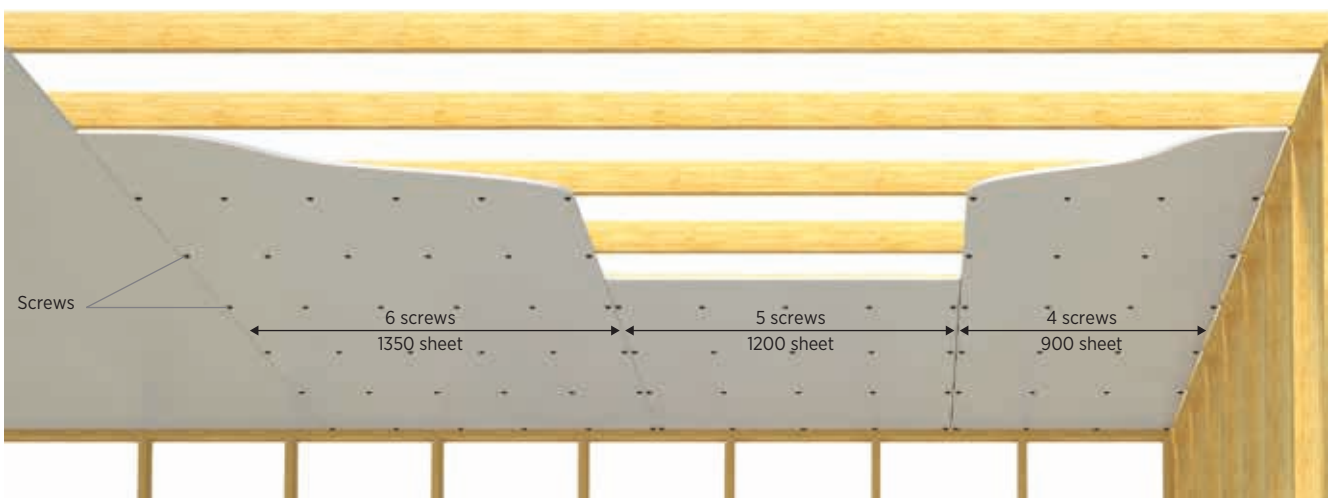

Figure 21: **Screw fixing (only) layout for ceilings**

» INTERNAL CEILINGS

BACK-BLOCKING

Back-blocking is a reinforcing system designed to minimise cracking and deformation along recessed edge and butt joints.

Back-blocking consists of plasterboard panels adhered to the back of sheet joints. USG Boral recommends the use of USG Boral Back-Blocking Adhesive or Cornice Adhesive - do not use stud adhesive.

Adhesive should be applied to back-blocking panels with 6mm notch trowel.

Australian Standard AS/NZS 2589 *Gypsum Lining – Application and Finishings* requires back-blocking of:

- all butt joints in ceilings
- recessed joints in Level 4 finish ceilings in any room containing three or more recessed joints
- all recessed joints in Level 5 finish ceilings.

NOTE:

USG Boral recommends that all ceiling joints should be back-blocked.

BUTT JOINTS IN CEILINGS

Wherever possible, avoid the need for butt joints by using full length sheets.

If sheets must be joined 'end-to-end' then the joints must fall mid-span between framing members and be supported by back-blocking panels (nom 400mm wide) for the length of the joint or between stitching battens (see below).

Back-Blocking Butt Joints

Butt joints can be back-blocked by forming a recess in the plasterboard face, where the sheet ends meet, using Rondo Stitching Batten or temporary wooden battens and packers.



Figure 22: Rondo Stitching Batten B005

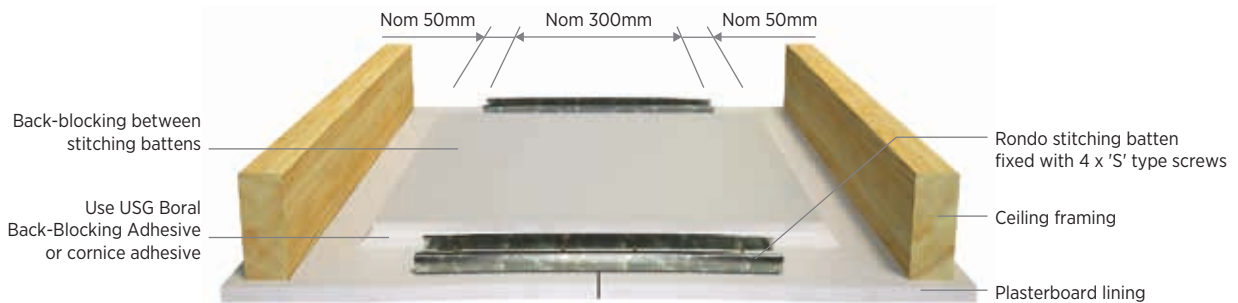

Figure 23: Back-blocking using Rondo Stitching Batten

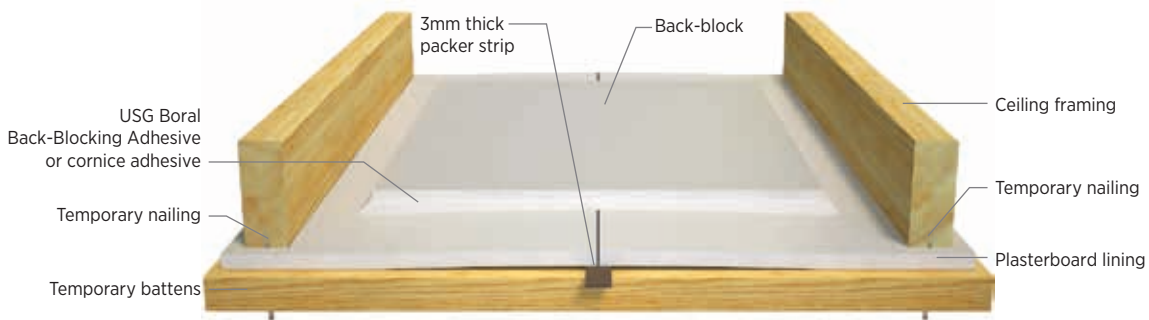

Figure 24: Back-blocking using temporary batten and packer

» INTERNAL CEILINGS

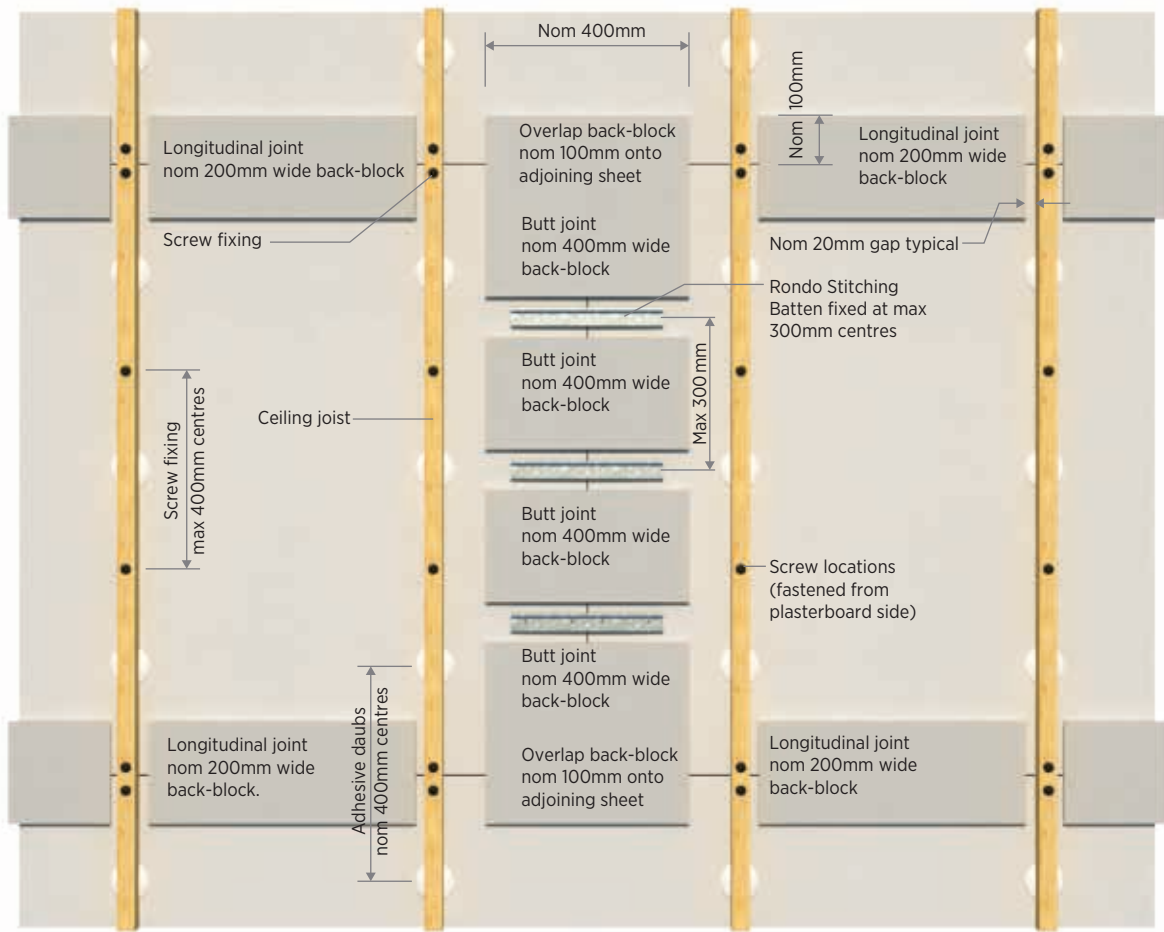

Figure 25: **Back-blocking using stitching battens – Plan view**

GARAGE AND EXTERNAL CEILINGS

GENERAL

Ceilings in garages, carports, verandahs and alfresco areas are subject to more extreme loads and conditions than normal internal ceilings and require special attention to their fixing and detailing.

Some factors contributing to these extra loads include:

- Wind loads
- Condensation
- Roller door vibrations
- Insufficient perimeter support
- Exposure to atmospheric variations (ie humidity, temperature, etc).

NOTES:

- External ceilings left unpainted for prolonged periods of time should be covered with a sealer coat to reduce the risk of board and compound deterioration.
- All Purpose compounds are not recommended for external applications.
- Consideration should be given to the use of plastic external angles in highly corrosive environments.

DESIGN NOTES

- The following USG Boral products are recommended for lining of garage ceilings, alfresco areas and other external protected ceilings:
 - 10mm SHEETROCK Ceiling Board
 - 13mm SHEETROCK Standard
 - 13mm STANDARD
 - 10mm UNISPAN
 - 13mm WETSTOP
 - 13mm FIBEROCK.
- Refer to Table 22 for maximum frame and screw spacings for external ceilings.
- Provide foil sarking and good ventilation to prevent heat build up and condensation pooling on the top of plasterboard.
- Provide a min 6mm wide gap between the edges of ceiling linings and adjacent walls, beams, columns and fascias.
- Fascia boards and perimeter beams should extend a min 25mm below plasterboard to provide a drip edge.
- Screws used for fixing of external ceiling linings must comply with *AS 3566 Self-drilling screws for the building and construction industries. Part 2: Corrosion resistance requirements.*

» GARAGE CEILINGS

INSTALLATION OF GARAGE CEILINGS

- Ensure there are adequate perimeter noggings.
- Use the 1/3 Fixing Method as illustrated in Figure 19.
- Fasten along the perimeter lines @ 300mm max centres as illustrated in Figure 26.
- It is recommended that the lower portion of the cornice is mechanically fastened to perimeter timber beams.
- A Rondo metal angle (P40), could also be fastened to the beam to provide concealed added support to the ceiling at the rear of the cornice.
- Thicken cornice adhesive to avoid dribble on brick wall face.
- When adhering cornice to masonry wall, apply Cornice Adhesive to the back of cornice so that it does not squeeze out under the bottom edge.

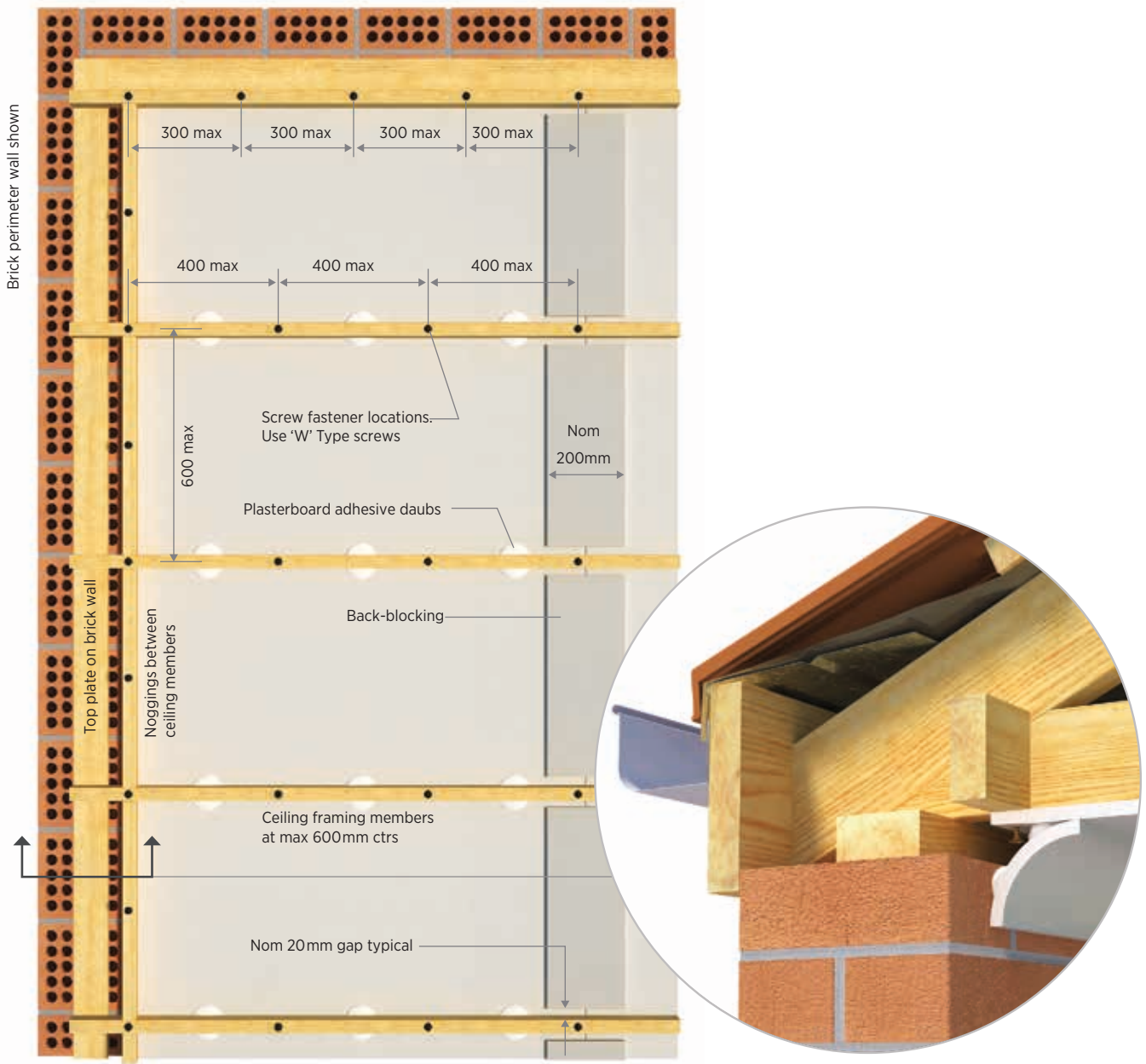

Figure 26: Garage ceiling fixing layout (1200mm wide plasterboard sheets shown)

Perimeter Detail

» EXTERNAL CEILINGS

INSTALLATION OF EXTERNAL CEILINGS

- Spacing between framing members should not exceed the maximum values indicated in Table 22. In areas where these values are exceeded, suitable ceiling battens or furring channels should be provided at required spacings. Metal ceiling battens and furring channels should be installed in accordance with Rondo specifications.
- Ceiling linings should be fully screw fixed at maximum spacings indicated in Table 22. Refer Table 11 and 12 for screw types.
- At sheet ends space screws at 300mm maximum centres for cornices and 150mm maximum centres for square set finish.
- Run plasterboard sheets at right angles to framing members.
- Back-block all joints in ceiling linings as per USG Boral back-blocking specifications.
- Control joints must be provided in external ceilings at max 6m centres in both directions.
- External ceilings should be painted with a three coat exterior paint system including a sealer undercoat and applied in accordance with manufacturer’s recommendations.

CEILING LINING		WIND CLASS			
		N1	N2	N3	N4
10mm SHEETROCK Ceiling Board	Max Framing Spacing (mm)	450	450	300	300
13mm SHEETROCK Standard					
10mm UNISPAN	Max Screw Spacing (mm)	300	300	250	200
13mm STANDARD					
13mm WETSTOP					
13mm FIBEROCK					



Figure 27: Alfresco area

» EXTERNAL CEILINGS

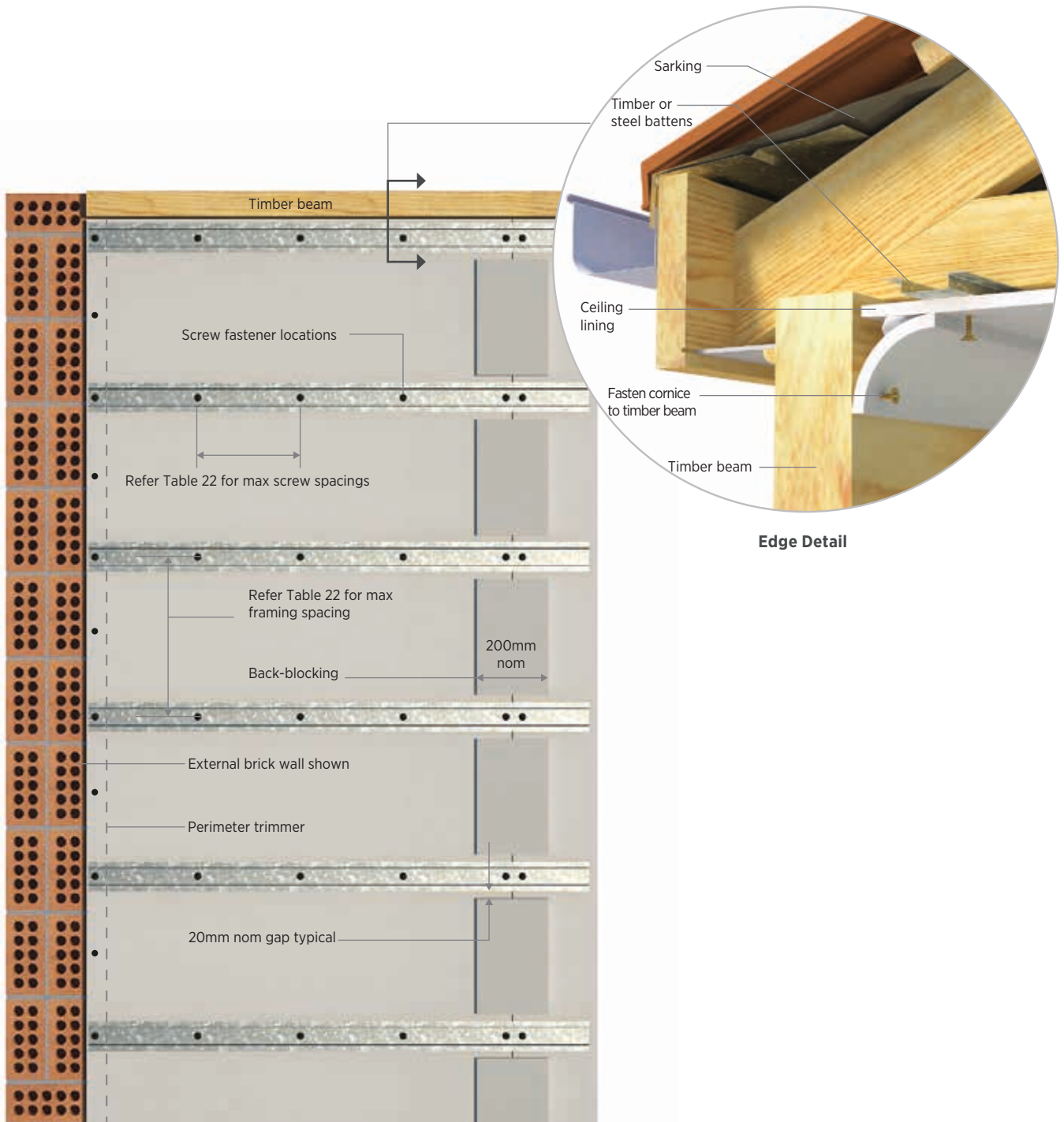

Figure 28: **External Ceiling Fixing Layout** (1200mm wide plasterboard sheets)

FRAMED WALLS

FIXING WITH COMBINATION OF ADHESIVE AND FASTENERS

- Space daubs at 300mm max centres along the studs.
- Space screws or nails at 300mm max centres at sheet ends (corners).
- Space nails at 150mm max centres or screws at 200mm max centres where butt joints are allowed on a framing member (Level 3 finish only).
- Refer to *General Screw and Nail Fixing* on page 20.

TEMPORARY FASTENERS

Under normal drying conditions, temporary fasteners (nails or screws driven through plasterboard blocks to hold sheets in place while adhesive cures) must be installed at every second stud and remain for at least 24 hours.

FIXING WITH SCREWS ONLY

- Space screws at 300mm max centres at internal and external corners and around door and window openings.
- Space screws at 200mm max centres where butt joints fall on a framing member (Level 3 finish only).
- Refer Table 23 and Figure 30 for wall fastener layout.
- Refer to *General Screw and Nail Fixing* on page 20.

NOTE:

Continuous fastening around door and window penetrations is optional as differential movement of wall framing, plasterboard linings and architraves is recommended for maintenance reduction.



Figure 29: **Combination adhesive and screw fixing on walls**

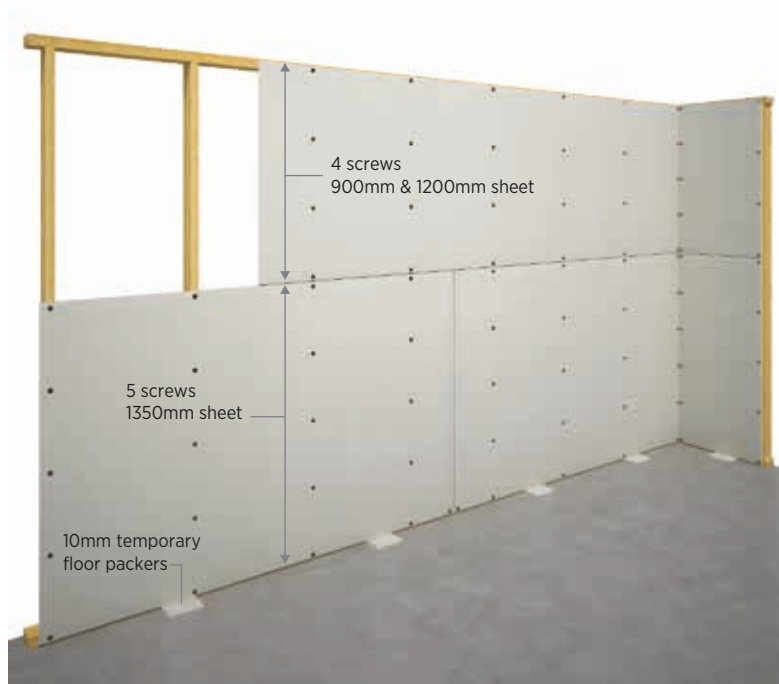

Figure 30: **Screw fixing to walls**

TABLE 23: SCREW FIXING (ONLY) LAYOUT FOR WALLS		
SHEET WIDTH	SCREW POINTS - FIELD	SCREW POINTS - SHEET END
900mm	4	4
1200mm	4	5
1350mm	5	6

Note: Screw points should be equally spaced.

» FRAMED WALLS

FIXING WITH NAILS ONLY (Level 3 finish only)

- Space single nails at 240mm max centres in the field and at sheet ends (corners).
- Space double nails at 400mm max centres in the field and at 300mm max centres at sheet ends (corners).
- Space nails at 150mm max centres where butt joints are allowed on a framing member (Level 3 finish only).
- Double nails should be 50-75mm apart.
- Refer Table 24 and Figure 31 for min number of nailing points per framing member.
- Refer to *General Screw and Nail Fixing* on page 20.

BUTT JOINTS IN WALLS

Wherever possible, avoid the need for butt joints by using full length plasterboard sheets.

If sheets must be joined 'end-to-end', the joints should fall within 50mm of the mid-span between framing members. Butt joints greater than 400mm in length and less than 2m above floor must be back-blocked with nom 400mm wide back-blocking panels for the length of the joint. Butt joints on opposite sides of the wall should fall between different framing members.

NOTE:

Butt joints in walls may be made on a framing member only if Level 3 finish is required.

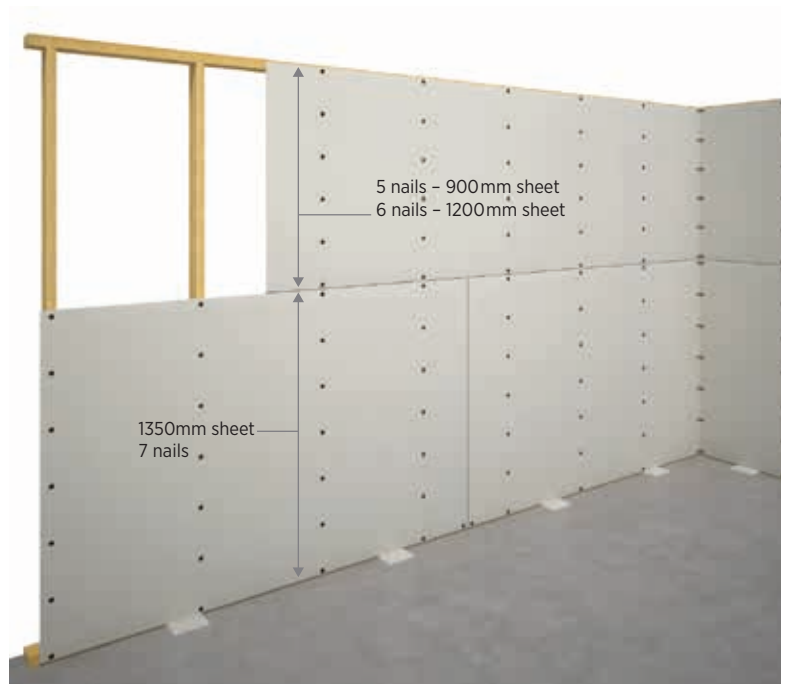

Figure 31: Nail fixing to walls (single nails)

TABLE 24: NAIL FIXING (ONLY) LAYOUT FOR WALLS		
SINGLE NAILS		
SHEET WIDTH	NAIL POINTS IN FIELD	NAIL POINTS AT SHEET END
900mm	5	5
1200mm	6	6
1350mm	7	7
DOUBLE NAILS		
SHEET WIDTH	NAIL POINTS IN FIELD	NAIL POINTS AT SHEET END
900mm	4	4
1200mm	4	5
1350mm	5	6

Note: Nail points should be equally spaced.

» FRAMED WALLS

INTERNAL CORNERS

The ends of plasterboard sheets at internal corners may be supported by one of two methods described below.

Where High Shrinkage timber is used (refer page 18) the sheets must not be nailed/screwed on either side of the corner and only Method 2 (both sheets floating) may be used. Use a metal angle (Rondo P40) to support sheet ends at internal angles with only one stud.

METHOD 1 – BOTH SHEETS FIXED

(Internal Corner with 2 studs illustrated).

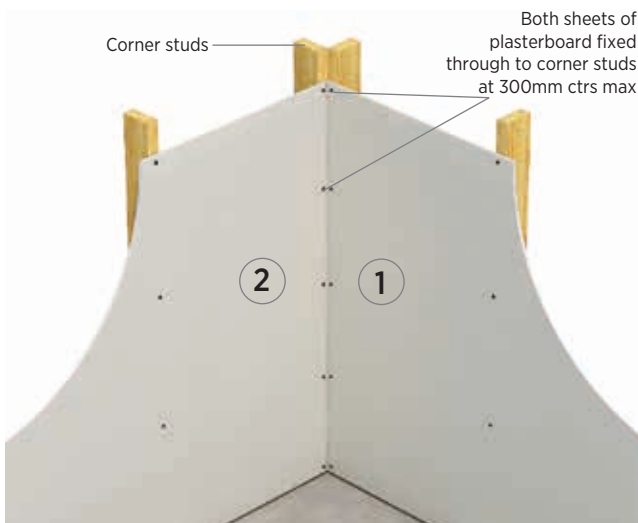

Figure 32: Internal Corner – both sheets fixed

- Fit the underlying sheet (1) firmly into corner and fasten along the edge at 300mm max centres.
- Fit the overlapping sheet (2) with the edge firmly against the first sheet and fasten at 300mm max centres.

METHOD 2 – BOTH SHEETS FLOATING

(Internal Corner with 1 stud and metal angle illustrated).

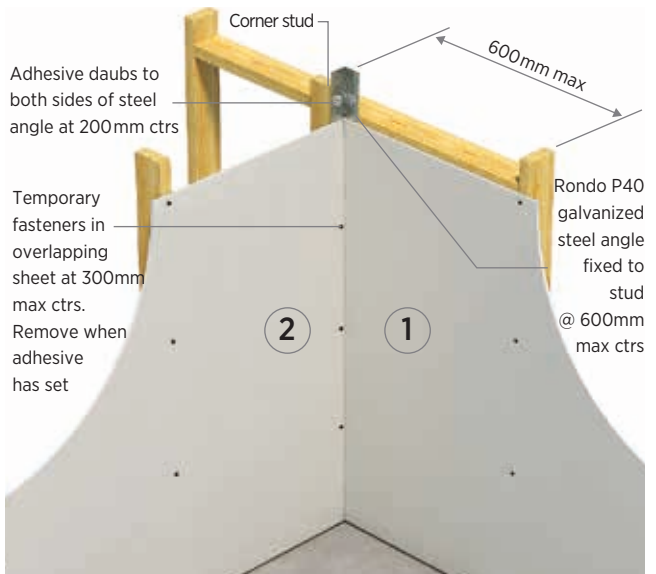

Figure 33: Internal Corner – both sheets floating

- Cut the metal angle 10mm shorter than the wall height and fix the angle to the stud @ 600mm centres.
- Apply stud adhesive daubs at 200mm max centres to both sides of the angle.
- Fit the underlying sheet (1) fully into the steel angle.
- Fit the overlapping sheet (2) hard up against the underlying sheet.

Apply temporary fasteners or surface blocks for 24 hours until adhesive has cured.



Figure 34: Rondo P40 Angle

» FRAMED WALLS

CONTROL JOINT INSTALLATION

Refer page 10 for guidance on control joint locations and construction.

Installation Procedure (P35 Control Joint):

- Leave gap of 20mm (nominal) between the ends of plasterboard sheets.
- Insert the surface mounted P35 Control Joint in the gap and fix by stapling or nailing on to the board at 300mm centres.
- Stop and finish the joint.
- When dry, remove the filament tape, protecting the centre of the P35, to leave a clean, neat joint.

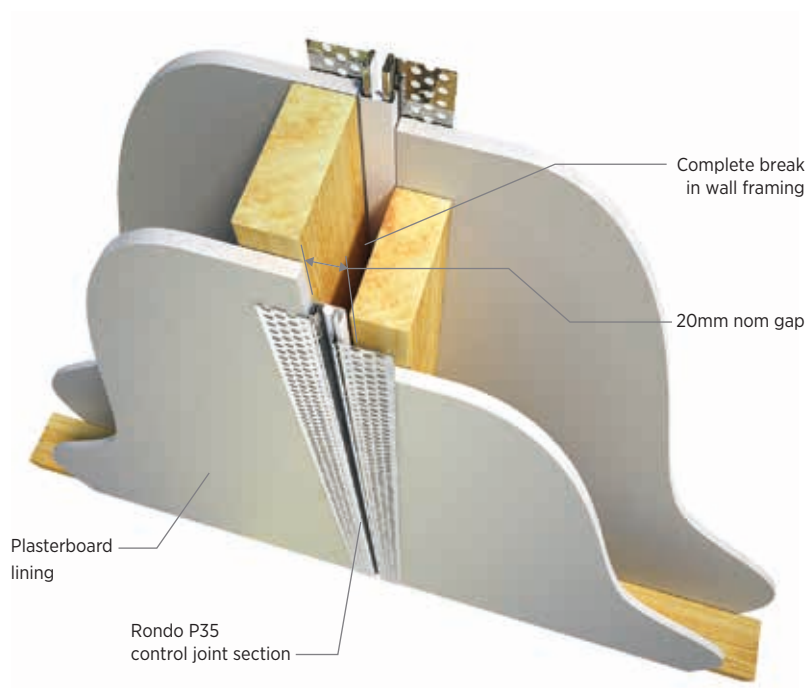
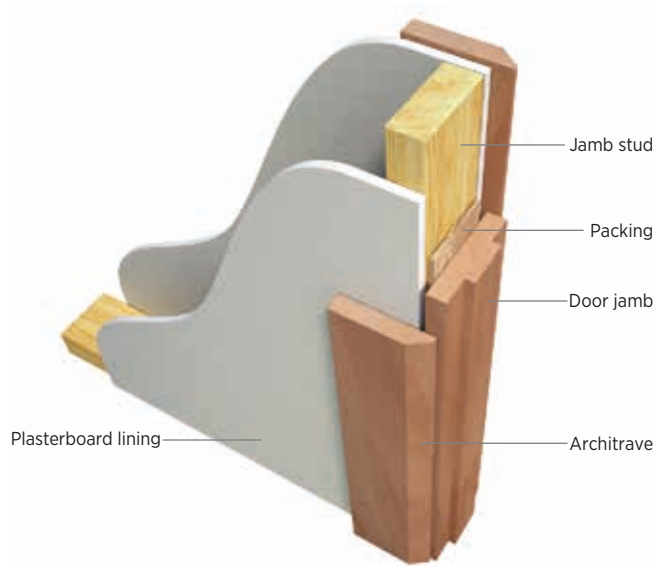
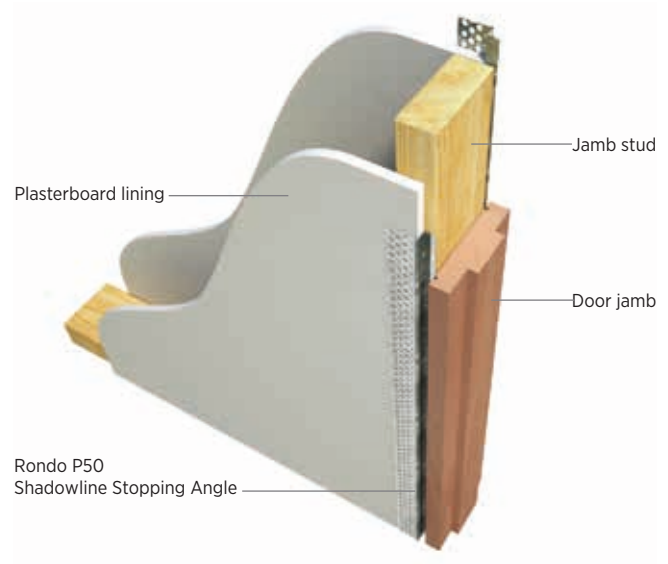

Figure 35: **Control joint in timber stud wall**



Figure 36: **Rondo Control Joint Section P35**

» FRAMED WALLS

DOOR JAMBSFigure 37 **Door Jamb With Architraves**Figure 38: **Door Jamb With Shadowline Stopping Angle****SHADOWLINE STOPPING ANGLE**

The Rondo P50 Shadowline Stopping Angle can be used to neatly finish plasterboard where:

- a set joint or internal corner is not possible
- cracking may occur
- a shadowline effect is required such as:
 - plasterboard and masonry wall junctions
 - ceiling and wall junctions
 - door and window jambs.

Figure 39: **Rondo Shadowline Stopping Angle P50**

» FRAMED WALLS

WALL-CEILING JUNCTIONS

Common treatments of timber framed plasterboard wall-ceiling junctions include the following:

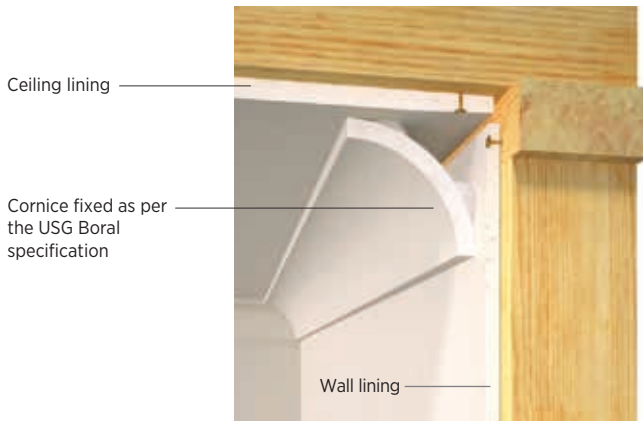

Figure 40: **Cornice Detail 1** (unsupported)

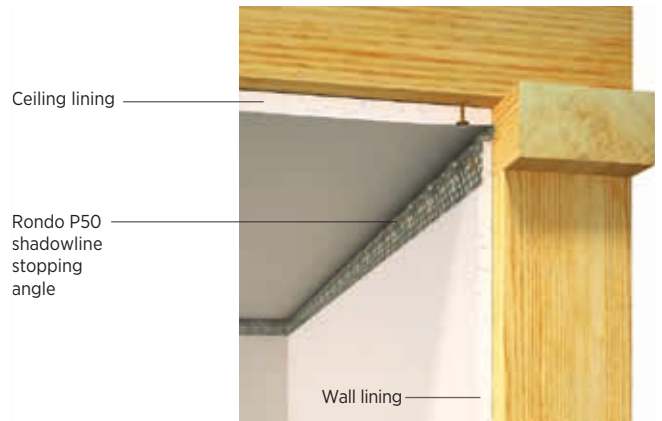

Figure 43: **Shadowline Angle 1**

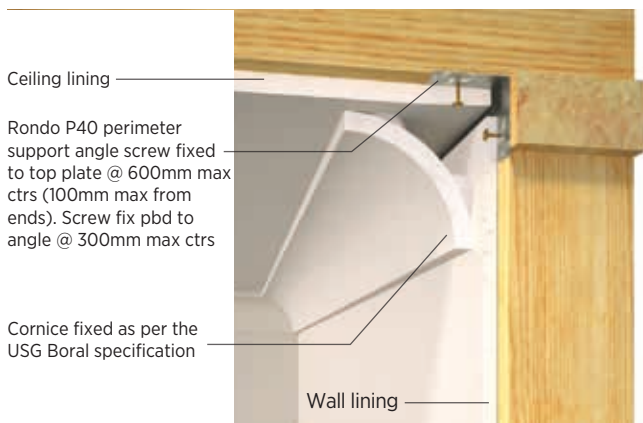

Figure 41: **Cornice Detail 2** (perimeter supporting angle)

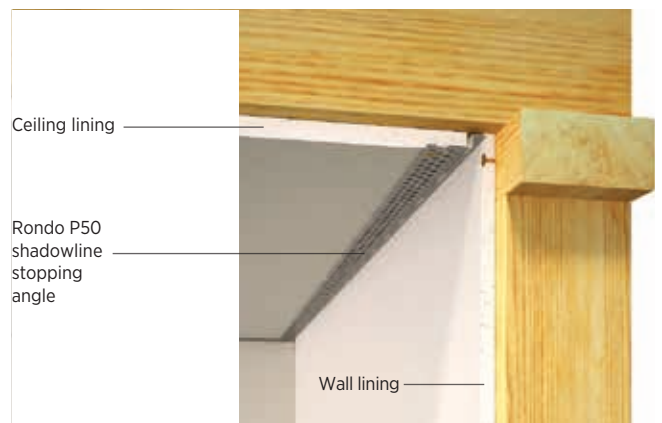

Figure 44: **Shadowline Angle 2**

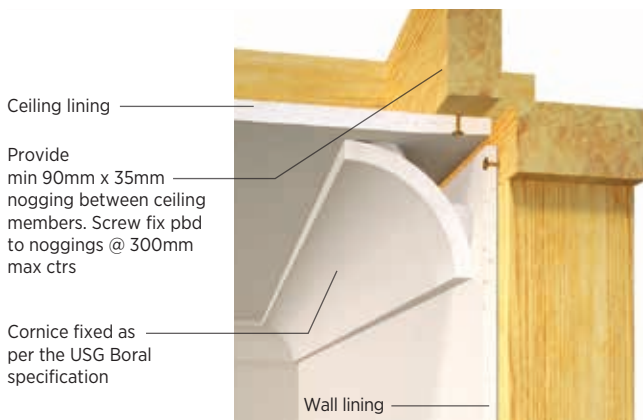

Figure 42: **Cornice Detail 3** (perimeter trimmers)

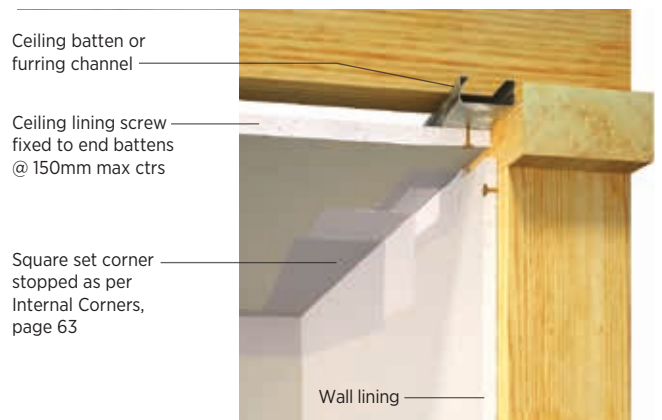

Figure 45: **Square Set**

NOTE:

Ceiling battens or furring channels are recommended for square set finish to minimise the risk of localised cracking.

MASONRY WALLS

GENERAL

USG Boral plasterboard provides a dry alternative to cement render and solid plaster finishes over masonry walls.

Two common installation methods are:

- Fixing sheets directly to masonry using USG Boral Masonry Adhesive
- Fixing sheets over timber battens or metal furring channels fastened to masonry.

The batten/furring channel method will allow a cavity space for services to run between the masonry wall and plasterboard as well as providing a true fixing surface and air flow ventilation.

It is essential that all new masonry surfaces be allowed to dry to in-service levels before installing USG Boral plasterboards.

Masonry walls in wet areas, such as bathrooms and laundries must be lined with WETSTOP or FIBEROCK as per the wet area installation requirements (refer page 41).

NOTE:

Linings in tiled and wet areas must be mechanically fastened to furring channels or timber battens.

Masonry walls should be checked for flatness and level using a straight edge or string line before determining the fixing method.

Masonry adhesive method should not be used for walls over 3m high or where the wall surface requires more than 25mm of packing to bring it back to a true line.

All services should be in place prior to plasterboard installation. Butt joints, control joints, jointing and finishing should be as per standard practice.

INSTALLATION USING MASONRY ADHESIVE METHOD

Masonry walls must be dry and free from dust, oil, flaking paint, efflorescence, release agents, or any other material or treatment that could adversely affect bonding of masonry adhesive.

Adhesion can also be affected by the porosity and/or previous surface treatment of a wall. Surfaces that are particularly dry or porous may need to be dampened. For best results masonry walls should be coated with a bonding agent before applying masonry adhesive.

NOTE:

It is important that plasterboard sheets for masonry applications are stacked flat as misaligned boards can hinder bonding process.

Masonry adhesive may be applied either to a wall or to the back of a sheet. (If gluing plasterboard to Autoclaved Aerated Concrete – AAC – then masonry adhesive should only be applied to the back of the sheet).

It is important to:

- Mix only enough masonry adhesive as can be used before it starts to set.
- Do not use masonry adhesive once it has started to set.

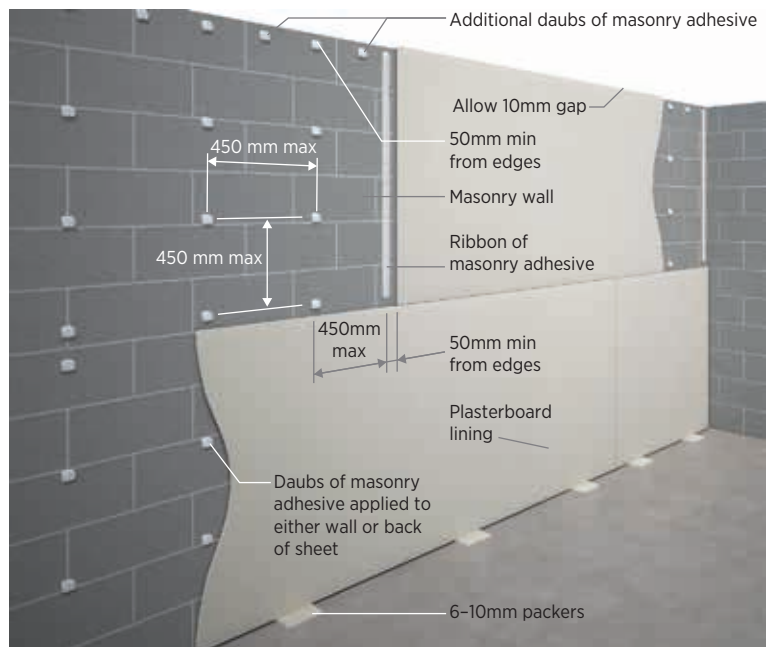

Figure 46: Fixing to a true wall surface

» MASONRY WALLS

**MASONRY ADHESIVE METHOD
INSTALLATION NOTES**

- Strike chalk lines on the floor and ceiling as a guide for positioning sheets. Allow for board and daub thicknesses.
- Mark lines on the wall to assist in positioning the masonry adhesive daubs.
- Masonry adhesive daubs should be about 50mm diameter by 15mm thickness.
- Space adhesive daubs at maximum 450mm centres vertically and horizontally and 50mm from free edges and ends of sheets.
- Ribbons or additional daubs of masonry adhesive must be applied at sheet ends and at cornice and skirting lines. Additional daubs of masonry adhesive are also required at external angles, fixtures and around services penetrations, doors and windows.
- Alternatively, a 'solid wall' effect can be achieved by applying cornice or masonry adhesive to the entire back face of the sheets, using a 15mm x 15mm notched trowel.
- Keep sheets 6–10mm off the floor.
- Place plasterboard and press firmly into position using a long straight edge to level the sheets vertically and horizontally.
- Hold the sheets in position with props or temporary fasteners until masonry adhesive sets.
- Once initial contact has been made, boards should not be pulled back from the wall.
- Once installed, boards should not be disturbed for 48 hours (ie no drumming or rattling of walls, cutting of light switches or power points).
- Avoid skinning of masonry adhesive in windy weather.
- Avoid early removal of bottom packers.

NOTE:

All fixtures must be fastened directly into masonry wall.

**FIXING TO IRREGULAR
WALL SURFACES**

Wall surfaces with high/low spots over 15mm or out of plumb by more than 15mm will need to be straightened with a series of levelling pads or by using furring channels.

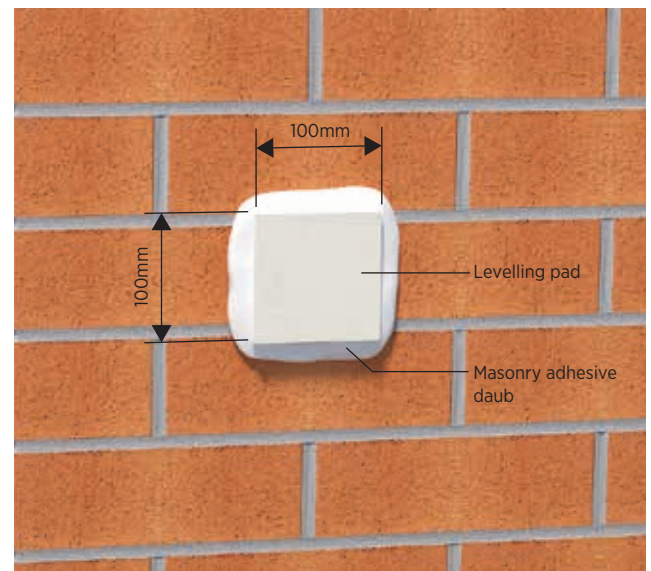

Figure 47: Levelling pads

» MASONRY WALLS

INSTALLATION USING FURRING CHANNELS

This installation method is particularly recommended for fixing to precast concrete panels.

Metal furring channels can either be direct fixed or clipped:

DIRECT FIXED CHANNELS

- Use one of the following:
 - Rondo Recessed Furring Channel 333
 - 42mm x 19mm (min) timber battens.
- Pack where required to achieve a true surface.
- Fix to masonry with suitable fasteners.

CLIPPED CHANNELS

- Use one of the following furring channels and fixing clips:
 - Rondo 129 or 308 Furring Channel
 - Rondo 237 or 239 Fixing Clips
 - Rondo Betagrip BG01 or BG02 Fixing Clips.
- Set out fixing clips for vertical channels spaced at maximum 600mm centres and for top and bottom horizontal channels.
- Pack clips where required to achieve a true surface.
- Fix clips to masonry with suitable fasteners.

Fix plasterboard to furring channels using an appropriate method (adhesive and fasteners or fasteners only) then joint and finish in the normal manner.



Figure 48: Masonry fixing clips

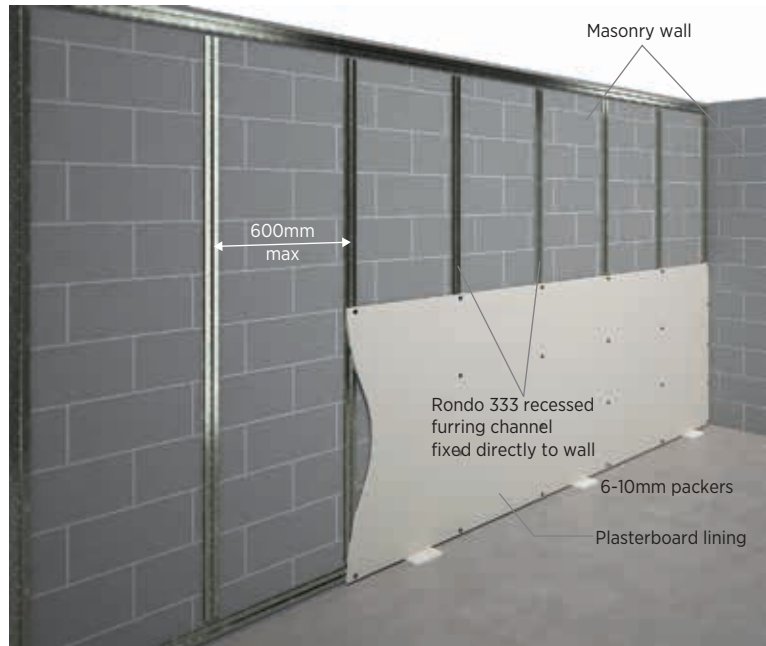

Figure 49: Fixing to furring channels fastened direct to wall

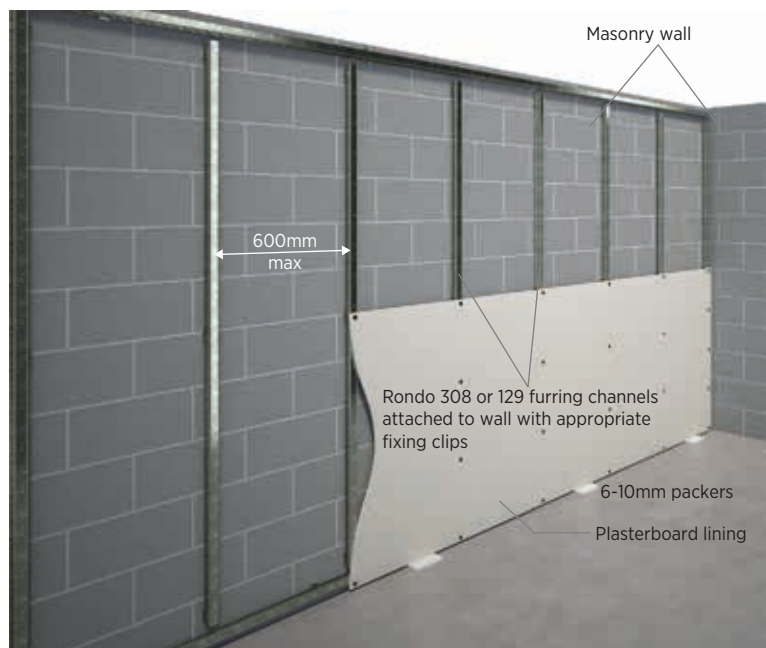

Figure 50: Fixing to furring channels clipped to wall

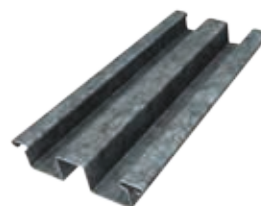

Figure 51: Rondo Recessed Face Furring Channel 333

WET AREAS

REGULATORY REQUIREMENTS

NATIONAL CONSTRUCTION CODE (NCC)

Wet area is defined in NCC as an area within a building supplied with water from a water supply system and includes bathrooms, showers, laundries and sanitary compartments.

According to NCC, wet area walls must be water resistant or waterproof to the extent specified and must comply with AS 3740 Waterproofing of domestic wet areas.

NOTE:

USG Boral Wet Area System requires total waterproofing of wet area walls with a waterproofing membrane complying with AS/NZS 4858 Wet Area Membranes and applied by a specialist contractor in accordance with membrane manufacturer's recommendations.

NCC requires waterproofing of the following junctions and penetrations:

Shower Areas (enclosed and unenclosed)

- Wall junctions within shower areas
- Wall/floor junctions within and outside of shower areas
- Penetrations in shower areas.

Areas Adjacent to Baths and Spas

- Wall junctions above inserted baths and spas.
- Shelf areas around inserted baths and spas.
- Tap and spout penetrations where they occur in horizontal surfaces around inserted baths and spas.
- Where a shower is above bath or spa, use requirements for shower.



» WET AREAS

Walls Adjoining Other Vessels (ie sink, basin or laundry tub)

- Wall junctions where a vessel is fixed to a wall.
- Tap and spout penetrations where they occur in surfaces required to be waterproof or water resistant.

Laundries and WCs

- Wall/floor junctions within laundries and WCs.
- Tap and spout penetrations where they occur in surfaces required to be waterproof.

Bathrooms and laundries required to provide a floor waste

- Wall/floor junctions

NOTE:

See also NCC State & Territory Appendices for additional waterproofing requirements in South Australia

AS 3740 WATERPROOFING OF DOMESTIC WET AREAS

AS 3740 sets out minimum material, design and installation requirements for waterproofing of wet areas within residential building and other buildings with similar usage intensity. It also outlines acceptable wet area materials and construction methods.

AS 3740 requirements include waterproofing of:

- All cut edges in water resistant plasterboard that have potential to be affected by moisture (including the bottom edge over a preformed shower base).
- Penetrations for taps, shower nozzles, recessed soap holders and similar fixtures by sealing with proprietary flange systems or a sealant.
- Any penetrations of mechanical fixings or fastening through surface materials.
- Membranes meeting the requirements of AS/NZS 4858.

For the purposes of AS 3740:

- Water-resistant plasterboard manufactured to AS/NZS 2588 *Gypsum Plasterboard* constitutes a water resistant substrate for tiles or other nominated water resistant surface materials.
- Membranes meeting the requirements of AS/NZS 4858 are deemed to be waterproof materials when used in waterproofing systems.

AS/NZS 4858 WET AREA MEMBRANES

AS/NZS 4858 sets out the performance and general test requirements for waterproof membranes as defined in AS 3740.

AS/NZS 4858 classifies membranes by their extensibility and requires the use of appropriate bond breakers for various classes of membranes:

MEMBRANE CLASS	EXTENSIBILITY	ELONGATION AT BREAK	MIN BOND BREAKER WIDTH TO BRIDGE JOINTS OPENING UP TO 5mm
I	Low	10-59%	75mm tape with backing rod
II	Medium	60-299%	35mm
III	High	= > 300%	12mm

» WET AREAS

USG BORAL WET AREA SYSTEM™

USG Boral Wet Area System comprises materials and installation details outlined in this manual and must be installed in accordance with USG Boral specification to achieve the required performance.

USG Boral Wet Area System complies with the requirements of AS 3740 and is thus suitable for use in residential buildings and other buildings with a similar usage pattern.

USG Boral Wet Area System is not suitable for use in high exposure applications such as group shower rooms, steam rooms, etc.

WET AREA MATERIALS**WETSTOP**

USG Boral WETSTOP plasterboard complies with water resistance requirements of AS/NZS 2588. Its moisture resistant core limits water wicking up the board causing damage to the board itself or to surface finish.

WETSTOP can be recognised by its blue-grey face liner and is manufactured with recessed edges for flush jointing within and outside of tiled areas.

WETSTOP complies with water resistance requirements of AS 3740.

WETSTOP is available in 10mm and 13mm thicknesses.

FIBEROCK

FIBEROCK is a water resistant paperless gypsum board offering additional benefits of mould resistance and high impact resistance. Fiberock contains 95% recycled materials.

Manufactured with recessed edges for flush jointing, FIBEROCK can be used as an alternative wall lining in USG Boral Wet Area System and can be installed using the same fixing, jointing and waterproofing materials and details as specified for WETSTOP.

Recessed edge FIBEROCK is available in 13mm and 16mm thicknesses.

USG Boral Wet Area Sealant™

USG Boral Wet Area Sealant is a flexible acrylic sealant suitable for waterproofing:

- Wall junctions and cutouts
- Bottom of sheets in shower bases or bath abutments
- Around plumbing fixtures and penetrations.

USG Boral Wet Area Sealant is available in 450g cartridges.

Waterproofing Membrane

Proprietary waterproofing membrane complying with the requirements of AS/NZS 4858 Wet Area Membranes and installed by a specialist contractor must be applied over the whole face of wet area walls in accordance with membrane manufacturer's recommendations.

Corner Support Angle

40mm x 40mm galvanised metal angle Rondo P40 is used to support internal corners in wet areas. It is available in 1.8m lengths.

PREPARATION OF WET AREAS

Check framing for layout and fixing of additional noggings to support wet area fittings such as screens and taps and the continuous support for USG Boral water resistant linings at the shower base and bath rims.

Provide adequate noggings 25mm (nominal) above bath, shower bases, tubs and sinks for fixing the edges of USG Boral water resistant linings.

Ensure that plumbing pipes and noggings do not protrude beyond the face of the studs.

Recess preformed shower bases and baths into studs so that USG Boral water resistant linings can sit correctly in front of the shower base upstand. This will provide a natural flashing point.

CEILINGS OVER WET AREAS

As NCC does not require the use of water resistant ceiling linings over wet areas, SHEETROCK, UNISPAN or STANDARD plasterboard provide an adequate solution for this application. WETSTOP or FIBEROCK can be used in wet area ceilings if water resistant linings are desirable.

Ceiling linings over wet areas in residential buildings can be fixed as per the standard internal ceiling installation specification (refer to page 21).

FIBEROCK gypsum board must be fully mechanically fixed (screws only).

NOTE:

USG Boral recommends that ceiling paint in wet areas should be impervious to moisture.

» WET AREAS

INSTALLATION IN TILED AREAS

- USG Boral water resistant linings in tiled areas must be fixed using a full fastener (screws only) system. Adhesive is not permitted.
- Space fasteners as per Table 26 and Figure 52.
- Sheets can be fixed horizontally or vertically with the bottom edge 6-10mm clear of the finished floor level or fixture.
- Lining sheets are best run the full length of the wall to avoid butt joints.
- Ensure sheets sit flat against framing.
- Neatly cut out penetrations and holes using hole saw and allowing approx 6mm gap for sealant.
- Fix 40mm x 40mm corner support angles where required leaving a 6mm gap at the bottom.
- Use screws as indicated in Tables 11 and 12 on page 20.
- Refer to General Screw and Nail Fixing on page 20.

TABLE 26: FASTENER SPACING IN TILED AREAS		
WALL TILES WEIGHT (INCLUDING TILE ADHESIVE)	MAX FASTENER SPACING	
	INTERMEDIATE STUDS	SHEET ENDS
No greater than 12kg/m ²	200mm	150mm
Greater than 12kg/m ² up to 32kg/m ² max	100mm	100mm

INSTALLATION IN NON-TILED AREAS

WETSTOP in non-tiled areas may be fixed as per standard installation specifications (refer to page 32).

FIBEROCK in non-tiled areas must be fixed using screws only.

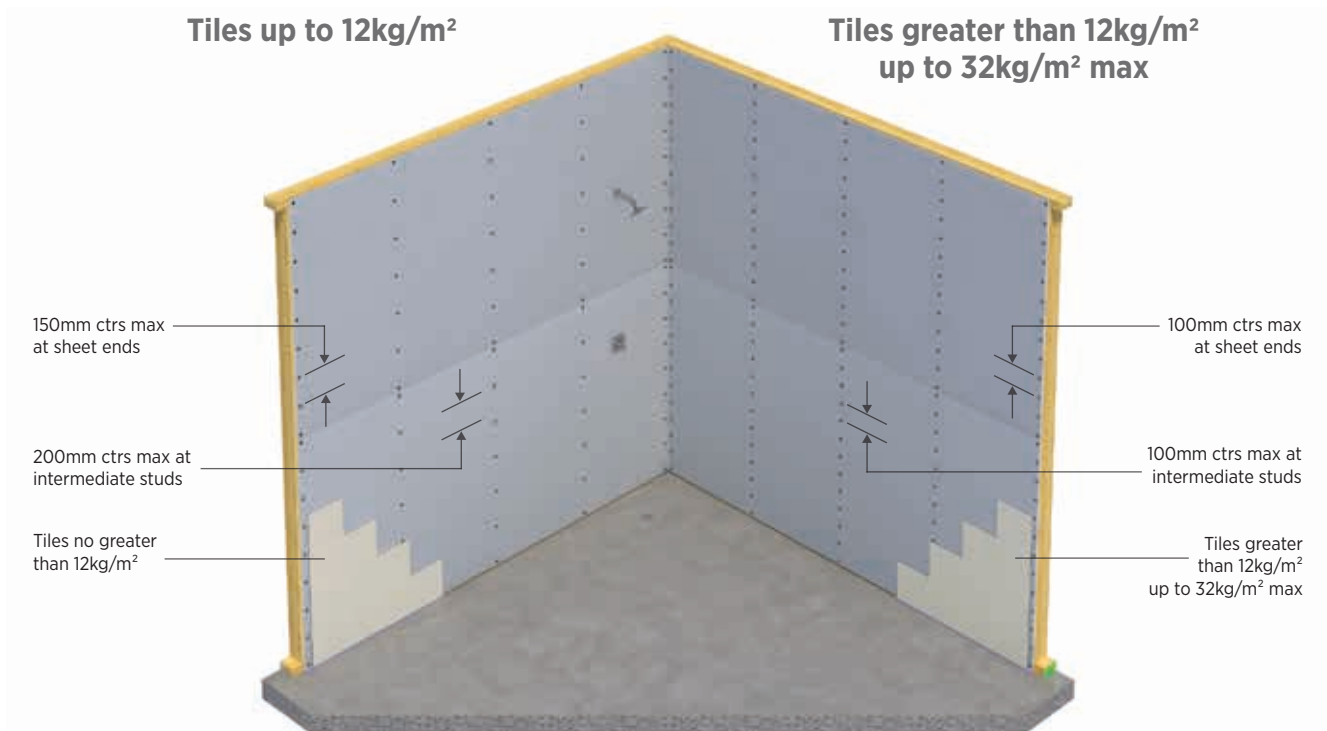

Figure 52: Plasterboard Fixing in Tiled Areas

» WET AREAS

WATERPROOFING OF WET AREAS

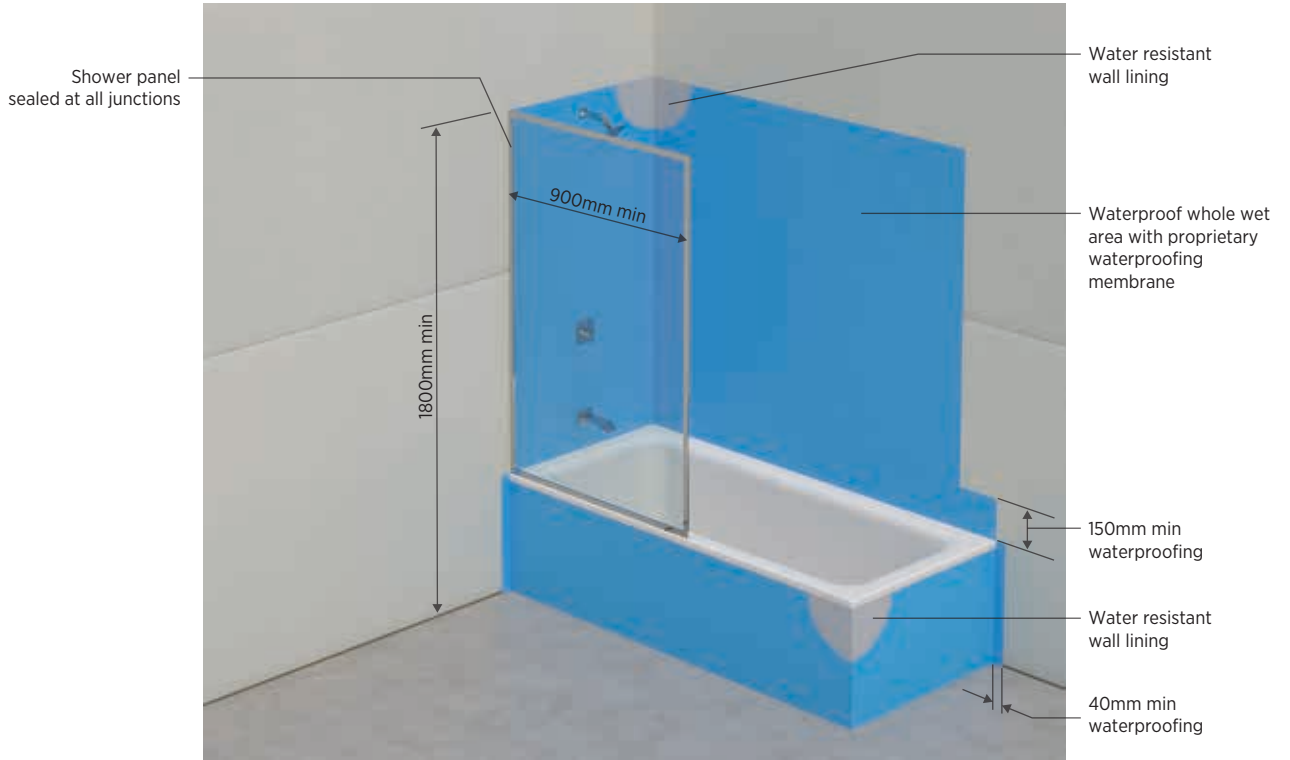

Figure 53: **Waterproofing of enclosed shower over bath**

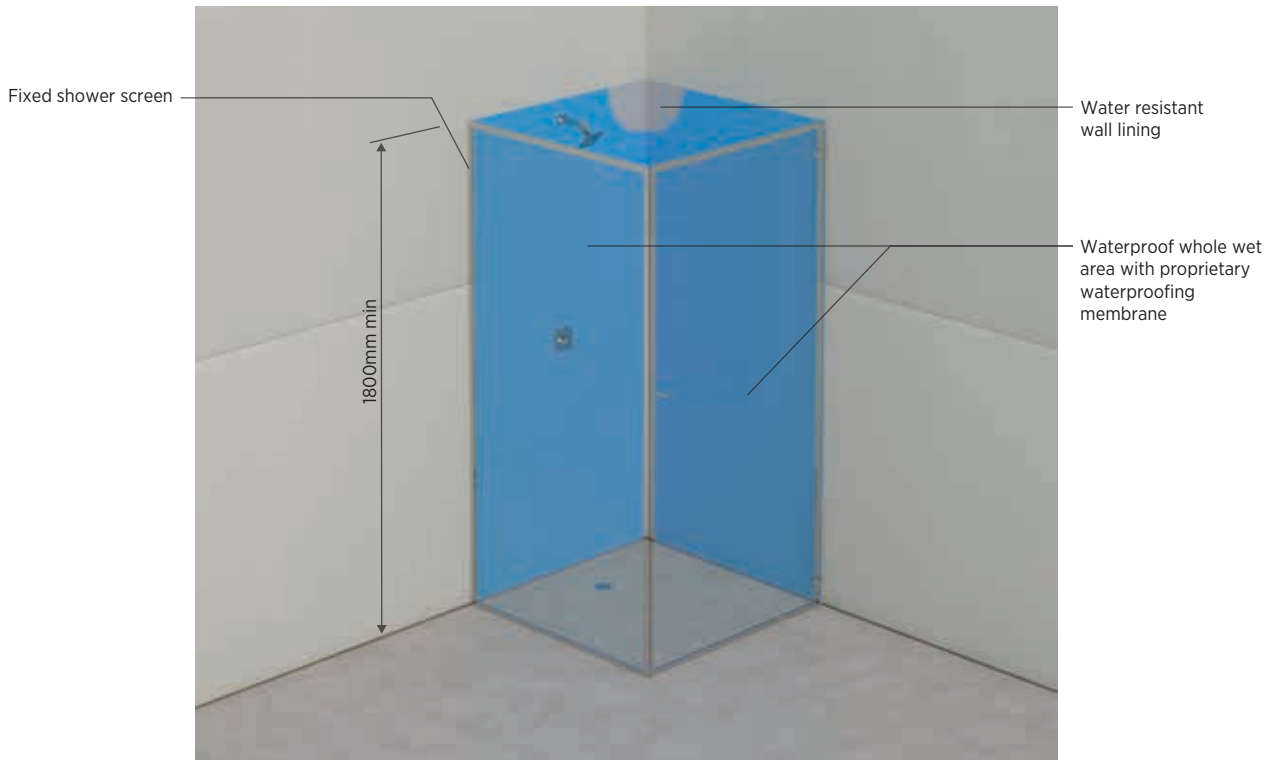

Figure 54: **Waterproofing of enclosed shower**

» WET AREAS

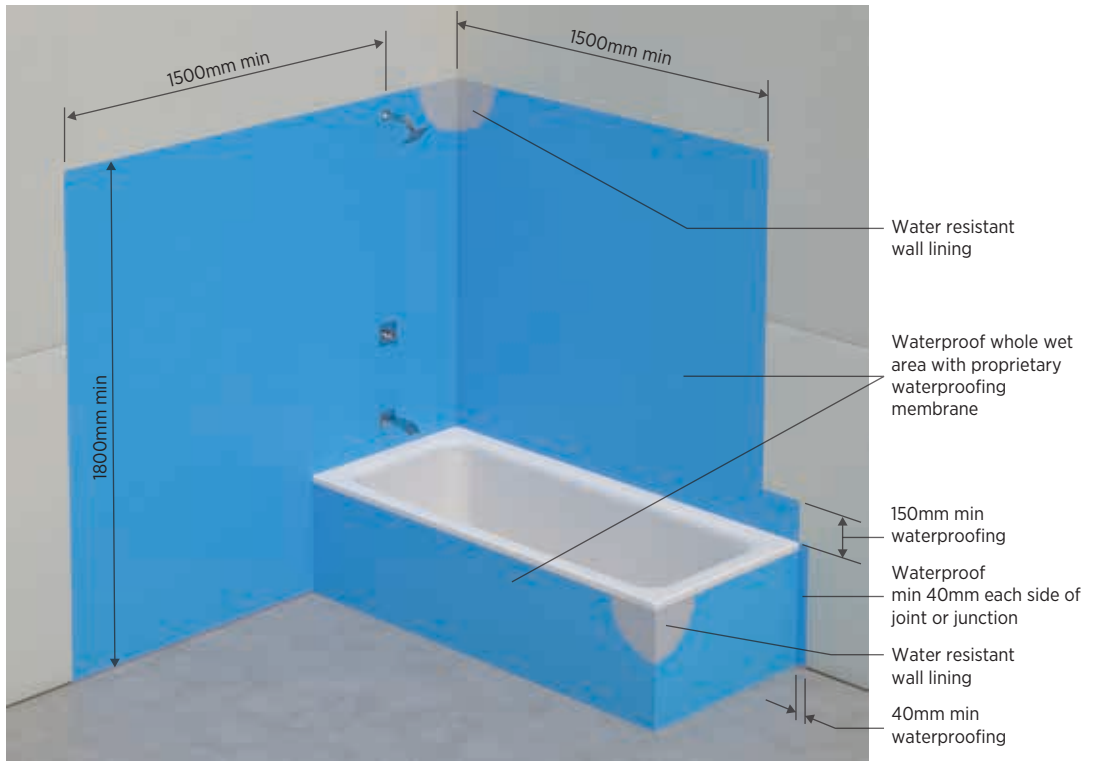

Figure 55: **Waterproofing of unenclosed shower over bath**

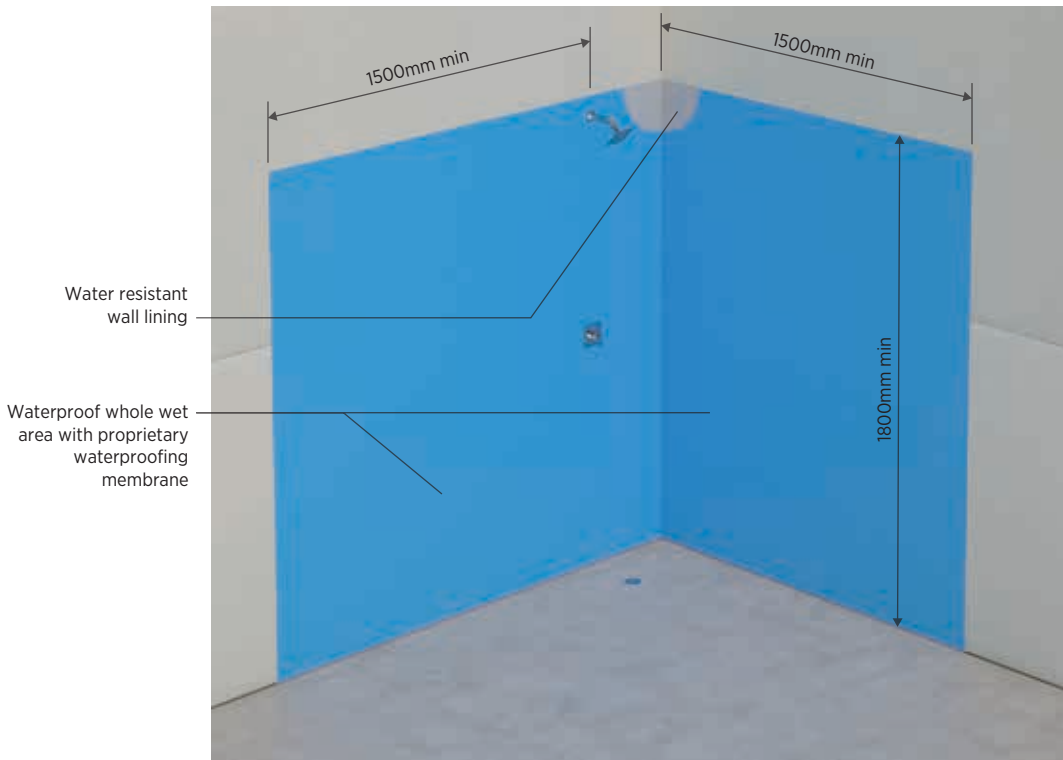

Figure 56: **Waterproofing of unenclosed shower**

» WET AREAS

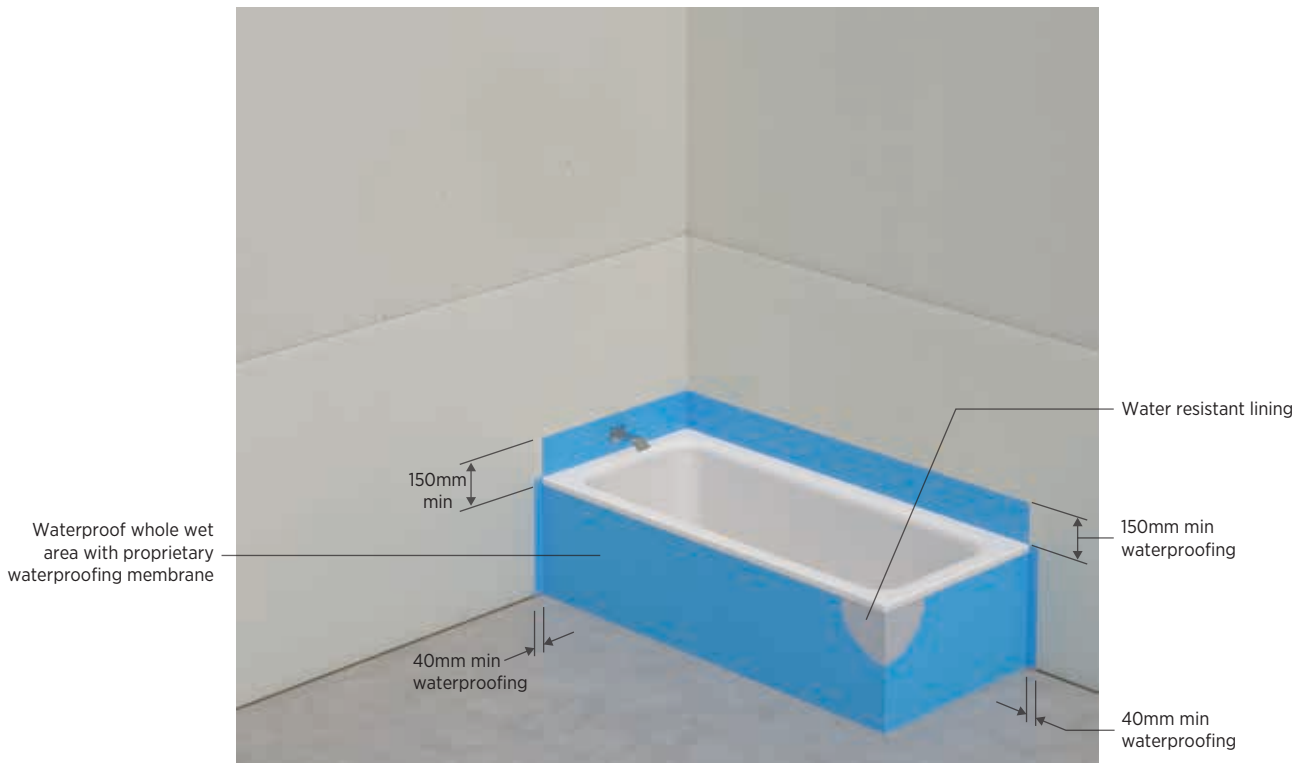

Figure 57: **Waterproofing of bath**



Figure 58: **Waterproofing of basin**

» WET AREAS

WATERPROOFING OF JOINTS AND JUNCTIONS

Joints and junctions within wet areas must be waterproofed prior to installation of tiling or other approved surface materials.

Cut edges of gypsum linings at wall-floor junctions, preformed shower bases and over bath lip must be protected by sealing with USG Boral Wet Area Sealant.

Waterproofing Wall Junctions

Waterproof sheet edges above baths, shower bases, laundry tubs, etc by sealing with USG Boral Wet Area Sealant for the full depth of the board (refer Figure 59).

Waterproof floor and wall junctions by sealing with USG Boral Wet Area Sealant for the full depth of the board (refer Figure 60).

Jointing in Wet Areas

USG Boral water resistant gypsum linings in wet areas must be jointed using USG Boral base compounds and paper tape (refer to Jointing section for application details).



Figure 59: **Seal Sheet Edges Over Baths, Shower Bases, Laundry Tubs**



Figure 60: **Seal Floor and Wall Junctions**

» WET AREAS

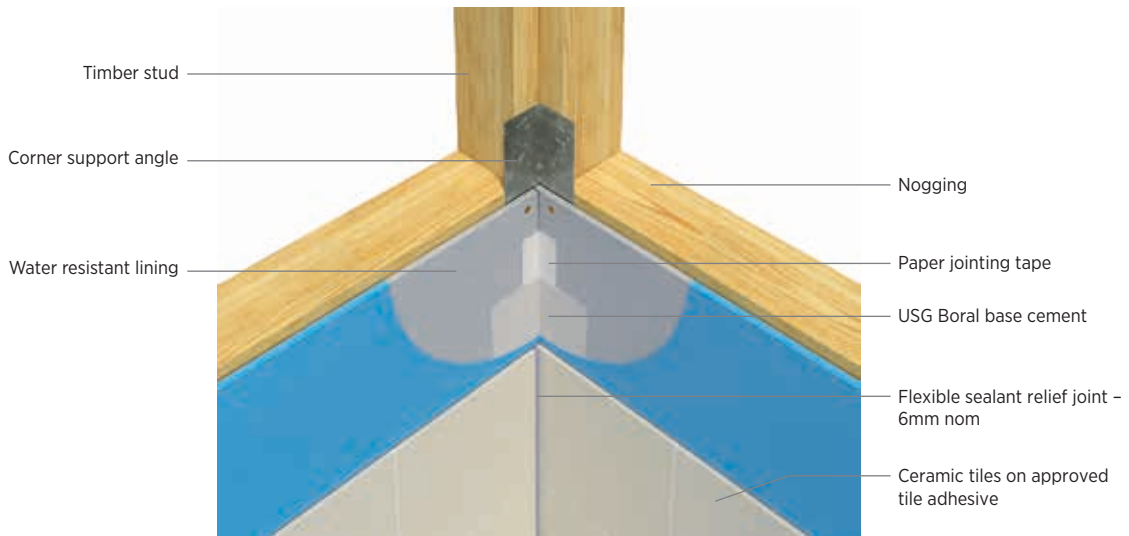

Figure 61: **Internal Corner**

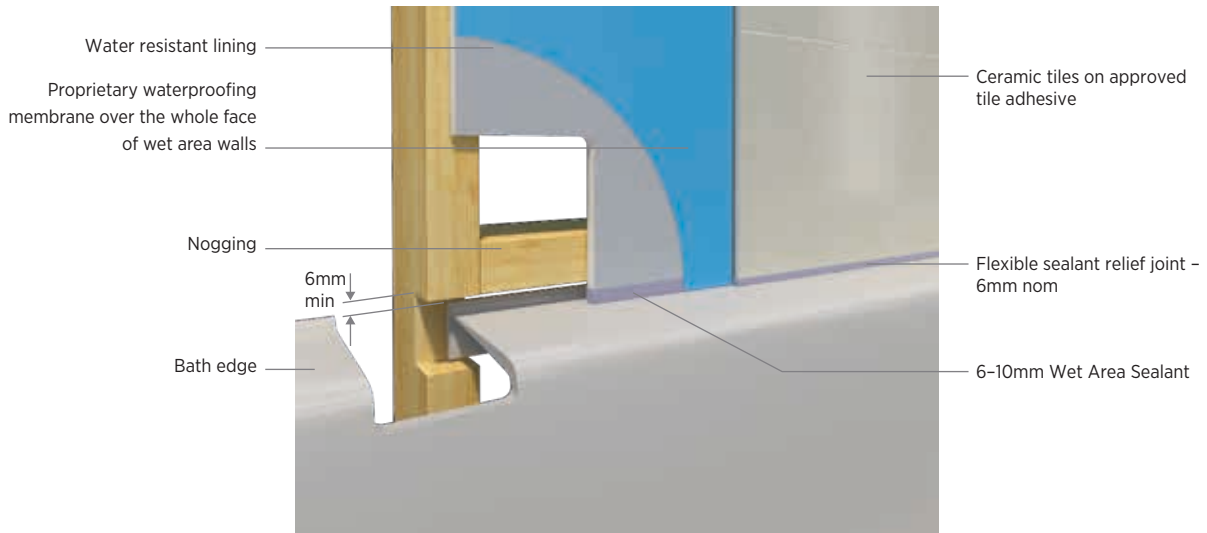

Figure 62: **Bath and wall junction**

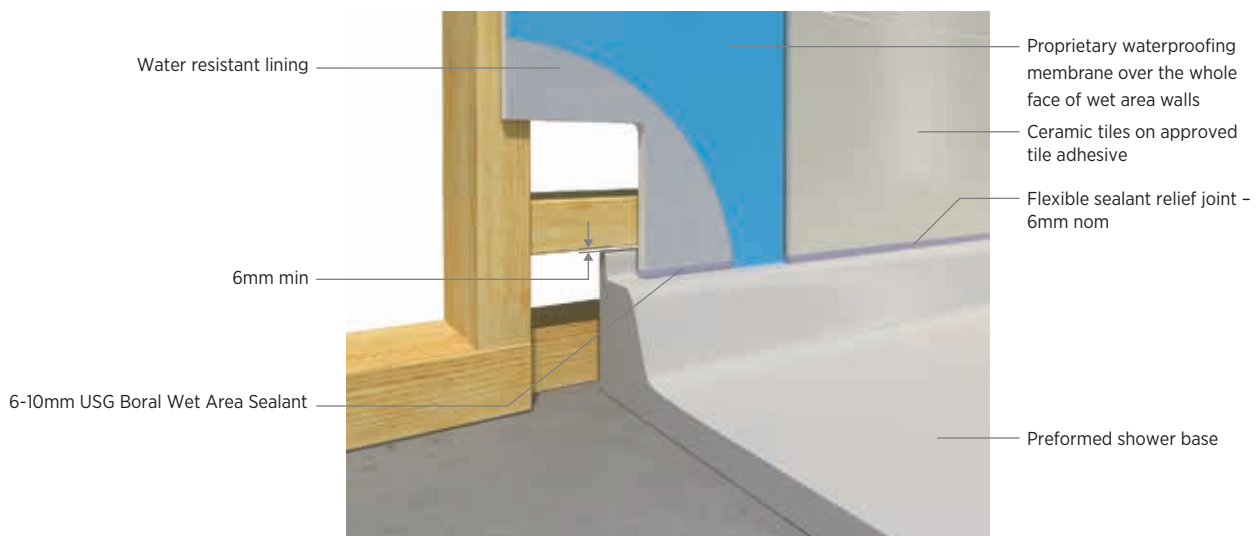

Figure 63: **Preformed shower base and wall junction**

» WET AREAS

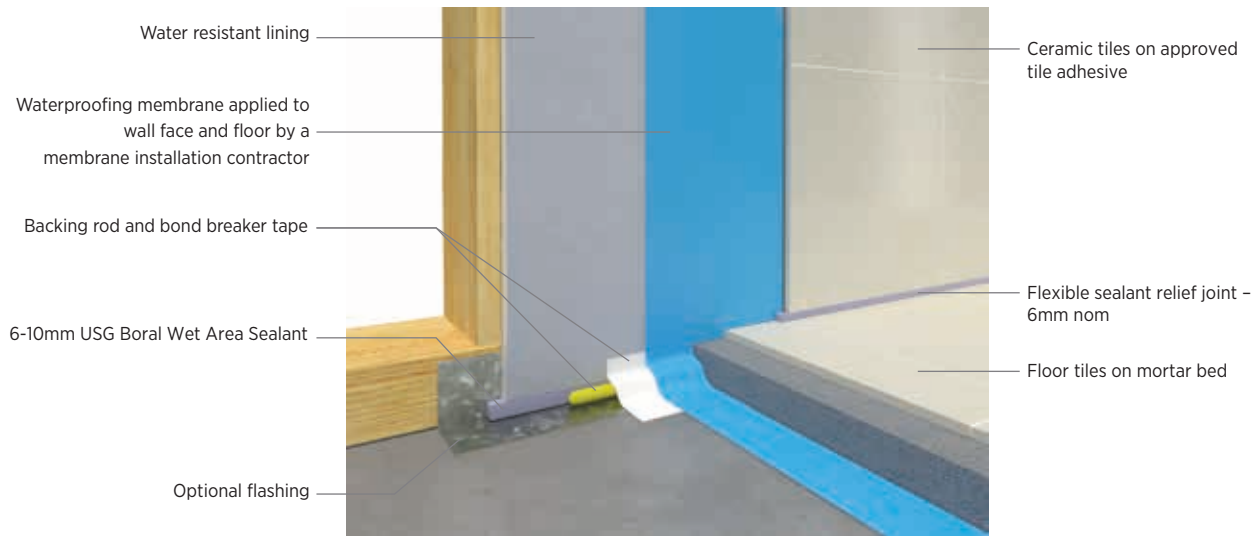

Figure 64: **In-situ shower base and wall junction** (Class I membrane)

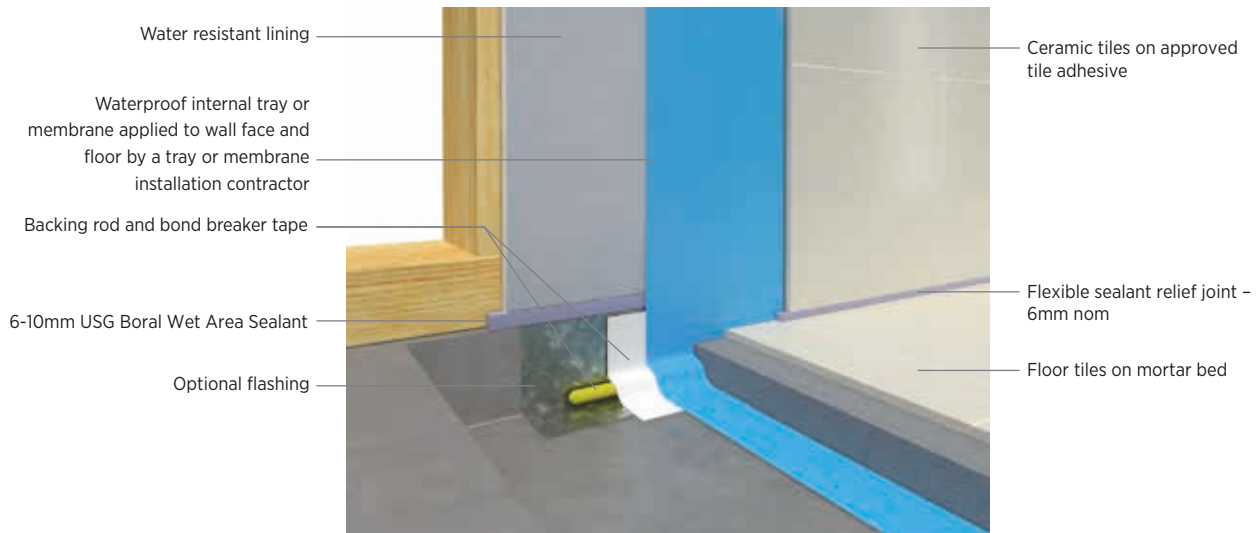

Figure 65: **Set-down shower base and wall junction**

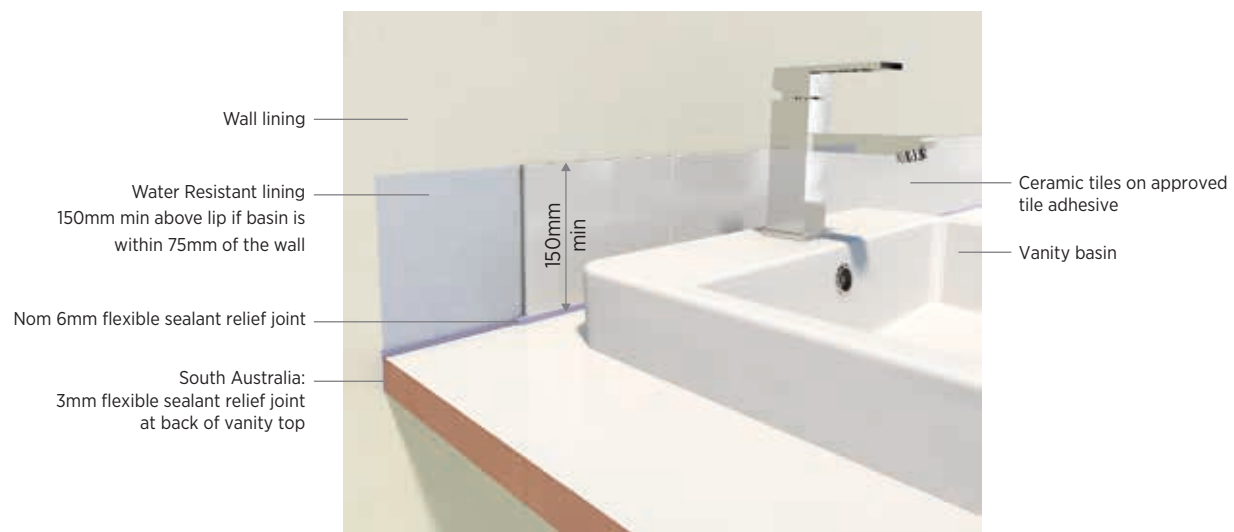

Figure 66: **Vanity unit and wall junction**

» WET AREAS

WATERPROOFING OF PENETRATIONS

Use hole saw to make penetrations for taps, shower nozzles and the like. Waterproof cut edges of gypsum linings at penetrations by sealing with USG Boral Wet Area Sealant for the full depth of the board (refer Figure 67). Alternatively, plumbing penetrations can be waterproofed with proprietary waterproofing components (refer Figure 68).

Cover fastener heads with a skim coat of USG Boral base compound.



Figure 67: **Plumbing Penetrations - Sealed**



Figure 68: **Plumbing Penetrations With Proprietary Waterproofing Components**

» WET AREAS

DO'S

USG Boral water resistant lining materials must:

- be fixed to framing only with mechanical fasteners when used as a substrate in tiled and wet areas. Stud adhesives must not be used in tiled or wet areas.
- be faced with ceramic tiles or other approved water resistant materials when installed in wet areas.
- only be applied to timber or steel framing or to a base layer of USG Boral water resistant lining material, never to other types of lining materials. Multiple layers of USG Boral water resistant lining materials must be fastened to framing individually.
- be jointed with paper tape.

DON'TS

USG Boral water resistant lining materials must not:

- be installed over a vapour barrier.
- be used in high exposure areas such as group shower rooms, steam rooms or enclosed pool areas.
- be used in unprotected external applications.
- be used if fractured or damaged.



Figure 69: **Finished bathroom**

CURVES AND ARCHES

Curves and arches can be constructed using USG Boral STANDARD or SHEETROCK, or for tight radii curves, 6.5mm FLEXIBOARD plasterboard.

CONSTRUCTING CURVED WALLS AND CEILINGS

The minimum bending radii for some USG Boral plasterboard products are as follows:

TABLE 27: BENDING RADII

PLASTERBOARD TYPE AND THICKNESS	MINIMUM BENDING RADIUS FOR PLASTERBOARD FIXED HORIZONTALLY
6.5mm FLEXIBOARD	650mm – concave
	450mm – convex
10mm STANDARD	900mm
13mm STANDARD	1000mm

Shorter radii can be achieved by moistening the compressed face of plasterboard. When wetting the board, apply a small amount of clean water with a paint roller or sponge. Allow the water to soak for 15 minutes before attempting to bend the board. To prevent flat areas between the studs, space framing closer together than normal.

NOTES:

- Screw fasteners are preferable to nails to minimise possible impact damage.
- Avoid butt joints occurring in the curved section of the wall by using plasterboard sheets of suitable length.
- Make sure the sheet edge (or end) is correctly aligned to framing before driving fasteners.
- Ensure the board is in close contact with framing when fasteners are driven.
- To ensure a smooth curve, fasten in the field of board only where necessary.
- Fasten only to studs, not to top or bottom plates.

Refer to relevant USG Boral publication for detailed instructions on fixing of FLEXIBOARD plasterboard.

ARCHES

Interior wall arches, framed in timber or steel, can be lined with STANDARD or SHEETROCK plasterboard and the arch angles reinforced with Rondo Arch Bead P10.

Straight corners below the arch line should be finished with standard corner bead, (Rondo P32 or P01).

Archway templates from min 12mm thick particleboard or MDF cut to the required profile must be in place before the installation of plasterboard sheets.

INSTALLATION

- Fix plasterboard sheets, horizontally, to studs on one side of the wall as per standard installation instructions.
- Screw/nail fix to templates and around the edge of the arch at maximum 300mm centres or use stud adhesive.
- Keep fasteners 10mm min from the edge of the arch.
- Do not place butt joints over or within 200mm of the arch.
- Allowing a 10mm projection beyond the template, accurately mark the profile of the arch on the back of the sheet.
- Cut out neatly with a keyhole saw.
- Fix sheets on the other side of the wall.
- From the cut side, square the line of cut across to the uncut sheet, mark the curve and cut out neatly as before.
- Cut a strip of plasterboard to fit into the arch soffit, allowing enough length to reach 50mm below the springing line on both sides of the arch.
- Apply continuous beads of cornice adhesive to the back edges of the wall sheets around the arch.
- If the arch has a tight radius, dampen the soffit strip to assist bending.
- Fasten one end of the soffit strip 50mm below the springing line and bed the strip into the cornice adhesive, progressively working around the arch.
- Check that the soffit strip is installed neatly and tightly throughout the arch and fix the free end.
- Cut plasterboard strips for the sides of the archway and fix using stud adhesive or fasteners.
- Bend Rondo Arch Bead into position around the arch with the short leg on the face of the wall. Allow a minimum of 150mm projection below the springing line at each end.
- Fix one end of the arch bead at the springing line, then fix around the remaining arch at maximum 300mm centres.
- Fit standard external corner beads (Rondo P32 or P01) to the straight sides of the archway and fix at maximum 300mm centres.
- Joint and finish as per standard methods.

» CURVES AND ARCHES

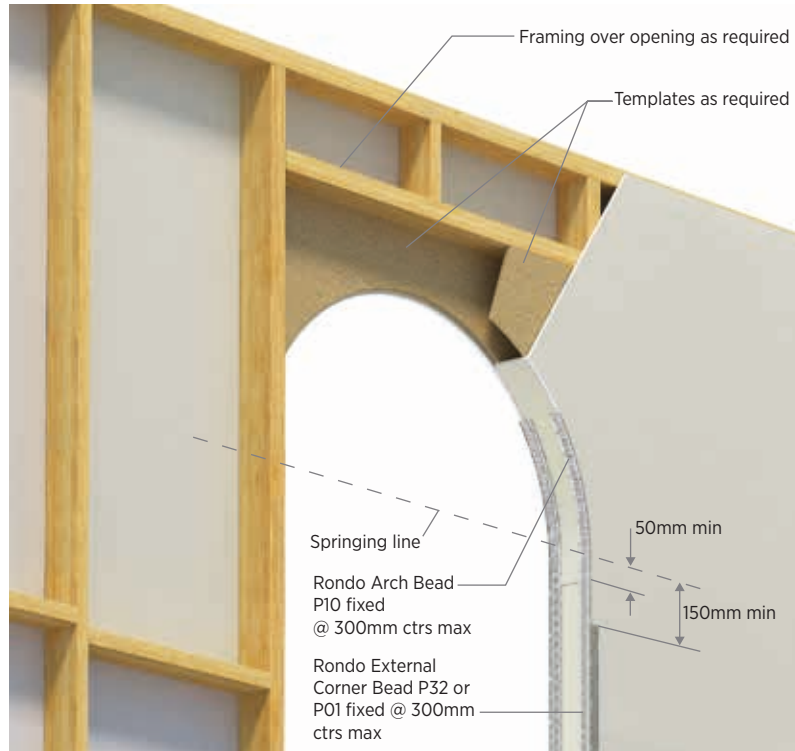

Figure 70: Arch construction

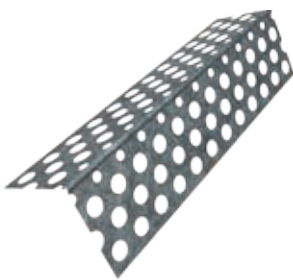

Figure 71: Rondo External Corner P01

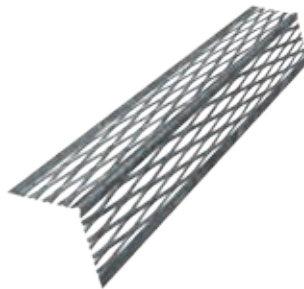

Figure 72: Rondo External Corner P32



Figure 73: Rondo Arch Bead P10

CORNICES

USG BORAL CORNICES



Sydney Cove (90mm)



Manly (75mm)



New York (90mm)



Cairo 2 Step (50mm)



Cairo 3 step (75mm)



Cairo 4 Step (100mm)



Linear (75mm)



Cove (90mm)



Cove (75mm)

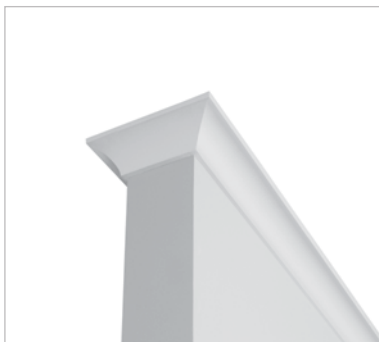

Cove (55mm)

Figure 74: **USG Boral Cornices**

» CORNICES

The installation specifications provided below are applicable to USG Boral paper faced cornices.

HANDLING AND LAYOUT

- Ensure cornices are stacked neatly away from traffic areas to protect profile and prevent damage.
- Cornice should be carried and handled 'on edge' to avoid cracking the core or wrinkling the paper liner.
- Where possible use full lengths of cornice and mitre all corner and butt joints.
- Ensure accurate and level placement by marking ceiling and walls with a line at the cornice edge.
- Install shorter lengths of cornice first then fit longer lengths by bowing out to spring mitres into place.

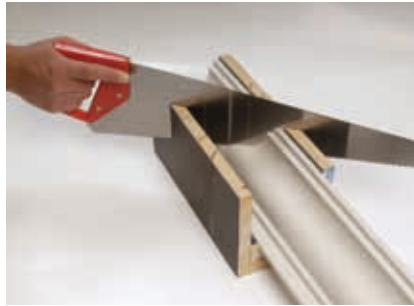

Position A



Position B



Position C



Position D

Figure 75: Cutting cornices using a mitre box

CUTTING CORNICE

- Measure, mark and cut cornice with a mitre cut each end, using a fine-tooth saw and a mitre box.
- Cut internal angles from the long point, and external angles from the short point.
- Check each cut piece of cornice for actual fit.
- Measure and pre-cut cornice to length before mixing the cornice adhesive.



Figure 76: Finished Cornice

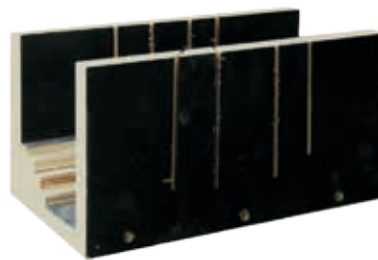

Figure 77: Cornice mitre box

» CORNICES

FIXING CORNICE

- Fix cornice to plasterboard walls and ceilings using USG Boral Cornice Adhesive with nails as temporary support for at least 20 minutes.
- If cornice is fixed to fibre cement linings, thoroughly wet the fibre cement at cornice line to prevent premature Cornice Adhesive dry-out and cracking at bottom edge.
- Apply 10mm minimum bead of Cornice Adhesive to top and bottom cornice edges.
- All mitres and joints to be buttered with Cornice Adhesive.
- Fibrous plaster cornice must be thoroughly dampened along mitres prior to the application of Cornice Adhesive.
- Large cast cornices and ceiling roses may require mechanical or other supplementary fixing. Refer manufacturers recommendations.
- Painted surfaces require scoring or abrading, or both, to provide an adequate key prior to the application of Cornice Adhesive and cornice.
- Cornice must be mechanically fixed around cupboards and onto timber beams.
- In hot and dry conditions, take care to avoid premature drying of adhesive and subsequent loss of adhesion. In these conditions, surfaces may need to be slightly dampened.
- Refer to Garage and External Ceilings on page 28 for additional installation requirements in these areas.
- When adhering cornice to masonry wall, apply Cornice Adhesive to the back of cornice so that it does not squeeze out under the bottom edge.

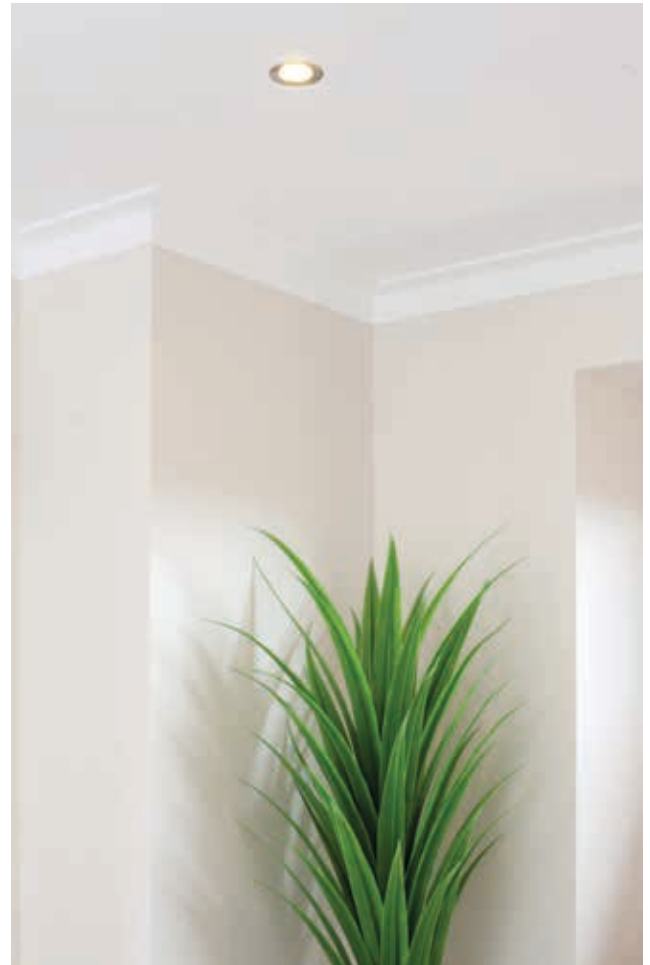

Figure 78: **Linear Cornice**

MIXING CORNICE ADHESIVE

- Only mix quantities of cornice adhesive that can be used before setting commences.
- Use clean potable water and clean containers for mixing.
- Add cornice adhesive powder to water and mix to a usable paste.
- Avoid overmixing as this may accelerate setting.
- Addition of other materials to cornice adhesive could impair its performance and is not recommended.

JOINTING

GENERAL

Jointing and finishing of plasterboard should be carried out according to the required level of finish (refer to Levels of Finish, page 11).

If no level is specified then Level 4 is the default level of finish for domestic construction. It requires all joints and external angles to be taped and coated as follows:

- Bed jointing tape into an initial coat of base compound.
- Apply a second coat of base compound to fill and level joints.
- Apply a coat of finishing compound.

Internal angles are to be completed with a two coat application.

The joint compound should be finished smooth and be free of tool marks and ridges.

Extreme care must be taken in jointing and finishing where walls or ceilings are subject to critical lighting (refer to Glancing Light sections on pages 13 and 67 and to USG Boral publication *Guide to Lighting and Decoration of Plasterboard*).

JOINTING COMPOUNDS

TYPES OF JOINTING COMPOUNDS

Jointing compounds broadly fall into two types: setting compounds and air-drying compounds. The jointing system may consist of one or both types of compounds and jointing tape.

Setting Compounds

Setting compounds are plaster based and mainly used for bedding tape and basecoating. They can be applied with either hand or mechanical tools and generally provide a stronger joint than air-drying compounds.

Air-Drying Compounds

Air-drying compounds are vinyl-based premixed compounds that can be used for base coating (all-purpose compounds only) and/or top coating. The use of air-drying type compounds in hot and dry conditions reduces the risk of premature dry out associated with plaster based setting compounds.

Air-drying compounds may require 24 hours drying time between coats, depending on weather conditions.

Air-drying compounds should not be applied when the interior temperature is less than 10°C.

Application of plaster based setting compounds over premixed air-drying compounds is not recommended. Paper tape must be used when taping with air-drying compounds.

STORAGE

Compounds should be stored in a dry place above ground and protected from the elements and temperature extremes. Storage in an unsuitable environment or once container or bag is opened can shorten the life of the product.

MIXING COMPOUNDS

For best results:

- Check the 'best before' date on packaging to ensure compounds are fit for use.
- Always use clean, cold potable water and clean containers and tools for mixing. Using dirty containers/ water/tools may affect the setting time and set strength.
- Slowly add powder to water and allow powder to soak before mixing.
- Mix only enough compound for stated working time when using setting compounds.
- Mix by hand or with a power mixer (max of 400rpm – mixing at higher speeds may draw air into the mix, creating air bubbles). Mix until a smooth workable paste has been achieved. Avoid overmixing as this may accelerate setting and shorten the working life of the compound.
- For setting compounds, once setting has commenced, the material cannot be remixed and should not be agitated or retempered by the addition of water.
- Inclusion of other materials in the mix could impair the performance of the compound and is not recommended.

NOTES:

- Setting compounds should be used with caution in windy, dry and hot conditions as compounds may dry out before setting occurs. Faster setting compounds or air-drying compounds are recommended for such applications.
- Subsequent coats of jointing compounds should not be applied 'wet on wet'.
- Overthinning of jointing compounds may cause shrinkage and hollow joints.

» JOINTING

USG BORAL JOINTING COMPOUNDS

USG Boral offers a wide range of jointing compounds suitable for a variety of application methods and requirements:

TABLE 28: USG BORAL JOINTING COMPOUNDS

APPLICATION	PRODUCT NAME	RELATIVE DENSITY	PACKAGING	TYPE	WORKING TIME	JOINTING			HAND TOOLS	MECHANICAL TOOLS	SANDING
						1ST COAT	2ND COAT	FINISHING COAT			
Base Compounds	EasySand™ 45	Lightweight	16kg bag	Setting	30mins	✓	✓		✓	✓	
	EasySand™ 90				70mins						
	BaseCote™ 45	Semi-lightweight	20kg bag	Setting	45mins						
	BaseCote™ 60				60mins	✓	✓		✓	✓	
	BaseCote™ 90				90mins						
	Taping Compound	Standard weight	17L / 28kg pail	Air-Drying	NA	✓			✓	✓	
	RediBase®	Semi-lightweight	18kg pail	Air-Drying	NA	✓	✓		✓	✓	
Finishing Compounds	Ultralightweight	Ultra-lightweight	17L / 17kg pail	Air-Drying	NA			✓	✓	✓	Very Easy
	Total Lite™ (Grey Lid)	Lightweight	17L / 22kg pail	Air-Drying	NA			✓	✓	✓	Very Easy
	LiteFinish™	Lightweight	18kg pail	Air-Drying	NA			✓	✓	✓	Very Easy
	FinalCote®	Semi-lightweight	20kg pail	Air-Drying	NA			✓	✓	✓	Easy
	TopCote 550®	Standard weight	20kg pail	Air-Drying	NA			✓	✓	✓	Easy
All Purpose Compounds	EasySand™ 5	Lightweight	8.1kg bag	Setting	6mins	✓	✓	✓	✓	✓	Moderate
	EasySand™ 20				20mins						
	All Purpose Premix	Lightweight	18kg pail	Air-Drying	NA	✓	✓	✓	✓	✓	Moderate
Level 5 Finish*	Tuff-Hide® (Primer Surfacer)	Paint consistency	18.9L / 30kg pail	Air-Drying	NA					Spray / Roller	Moderate
	Diamond™ Veneer Finish	Standard weight	20kg bag	Setting	60mins				✓		

* Refer to Levels of Finish on Page 11

» JOINTING

JOINTING TAPES

Jointing tapes are used to provide reinforcement to plasterboard joints and angles.

USG Boral SHEETROCK paper tape is a high strength special cross-fibre paper tape possessing exceptional wet strength and resisting stretching, wrinkling and tearing.

A wafer thin paper aids smooth finishing and the roughened surface produces a superior bond to jointing compounds.

Centre creased for application to angles.

Paper tape is recommended by USG Boral for jointing of gypsum wall and ceiling linings due to its high strength and suitability for all jointing compounds and applications.

Paper jointing tape must be used in wet area and fire rated applications or with air-drying type jointing compounds.

USG Boral SHEETROCK jointing tape is available in 75m and 150m x 50mm wide rolls.

NOTE:

As the two sides of paper tape are not identical, the outside of the roll should always be applied to the wet plaster compound to ensure the best adhesion.



Figure 79: Paper Jointing Tape

STOPPING RECESSED JOINTS

Recessed joints should be stopped and finished with a straight or curved trowel to leave a slightly convex camber over the joint.

FIRST COAT

- Fill any gaps in joints with base compound prior to the taping process.
- Fill recessed joint with a layer of base compound using a flexible 150mm broadknife.
- Centre and press the paper tape into the base compound using a 150mm broadknife, drawing along the joint with sufficient pressure to remove excess compound.
- Ensure all air bubbles have been expelled, taking care sufficient compound is left under the tape to provide a strong bond.
- After embedding tape, apply a skim coat of compound to fill the recess.
- Spot fastener heads.

SECOND COAT

- Allow sufficient time for the first coat of base compound to set.
- Apply a second coat of base compound approx 200mm wide, using a trowel or broadknife.
- Feather joint edges.
- Spot fastener heads again, extending beyond the first coat by approx 25mm.

FINISHING COAT

- Ensure base coats are set and scrape to remove any rough spots or lumps.
- Using a trowel, apply a coat of finishing compound approx 250mm wide, feathering out approx 25mm beyond edges of the basecoat.
- Use a curved trowel on the finishing coat to produce a slight convex curve. Feather out the edges.
- Allow a minimum of 24 hours to dry (longer in cold, wet weather conditions).
- When dry, lightly sand to a smooth finish with sanding mesh or 150-220 grit paper, depending on sanding hardness of finishing compound used.

» JOINTING



1. First coat - Bedding compound



2. First coat - Bed tape

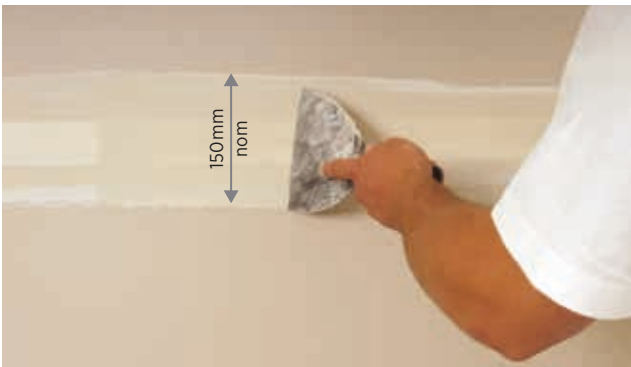

3. First coat - Skim coat

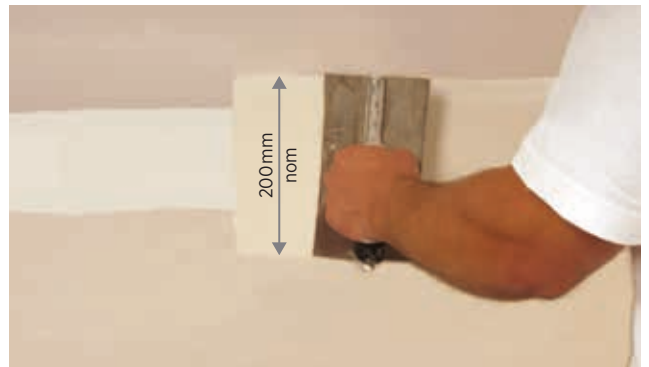

4. Second coat

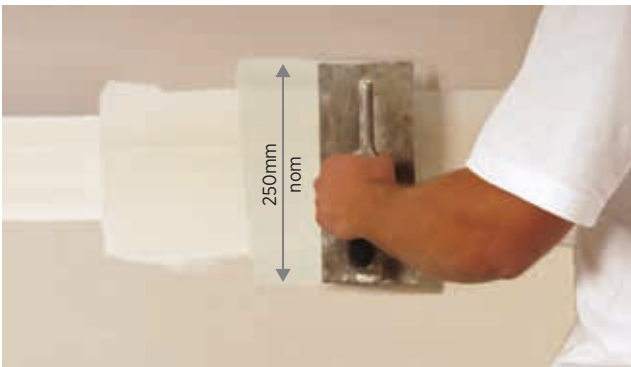

5. Finishing coat



6. Dry sanding

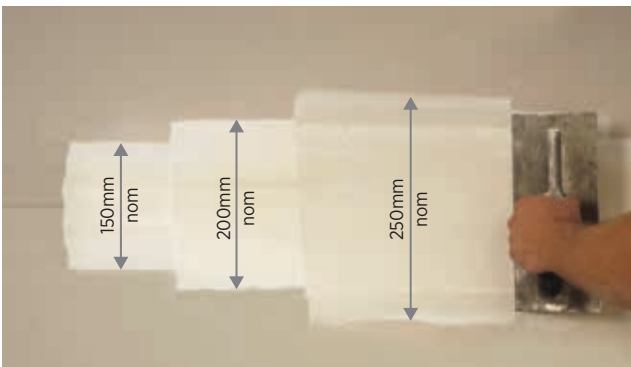

7. Total recessed joint system

Figure 80: Stopping Recessed Joints

» JOINTING

STOPPING BUTT JOINTS

Butt or end joints should be flush-jointed and finished with a three coat system as for recessed joints.

For a flatter finish, and to minimise surface build-up of compound, widen each jointing coat so that the final coat of the finished joint is about 500mm wide.

FIRST COAT

- Fill in any gaps in joints with base compound prior to the taping process.
- Using a trowel, apply a thin layer of base compound to each side of the joint (approx 300mm total width) prefilling any recess gaps at the joints.
- Centre and press the paper tape into the base compound using a 150mm broadknife, drawing along the joint with sufficient pressure to remove excess compound.
- Ensure all air bubbles have been expelled, taking care sufficient compound is left under the tape to provide a strong bond.
- After embedding tape apply a skim coat of compound over the paper tape.

SECOND COAT

- Allow sufficient time for the first coat of base compound to set before applying a second coat.
- Apply a second coat of compound to each side of the joint (approx 400mm total width).
- Feather out joint edges.
- The second coat should have a gradual convex curve.

FINISHING COAT

- Ensure base coats are set and remove any rough spots or lumps.
- Using a straight bladed trowel, apply a coat of finishing compound to each side of the joint (approx 500mm total width). Feather out the edges.
- The finished coat should have a slight convex curve.
- Allow a minimum of 24 hours to dry (longer in cold, wet weather conditions).
- When thoroughly dry, lightly sand to a smooth finish with sanding mesh or 150–220 grit sand paper, depending on sanding hardness of finishing compound used.

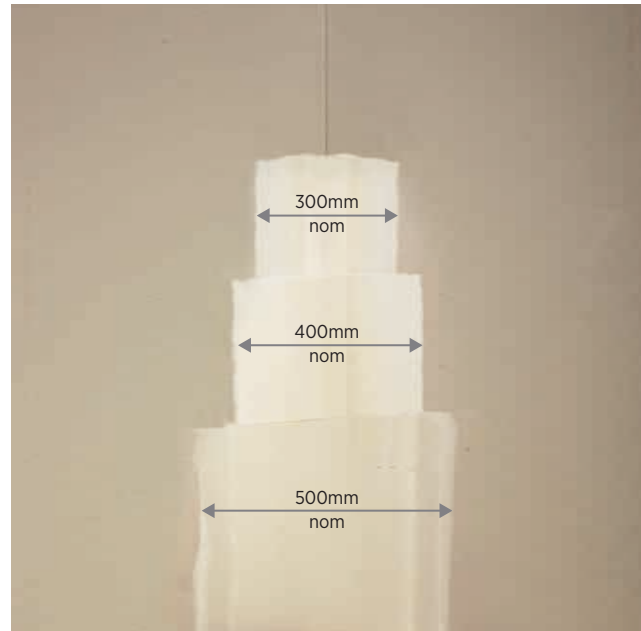

Figure 81: **Stopping Butt Joints**

» JOINTING

STOPPING CORNERS**INTERNAL CORNERS**

Internal corners should be jointed with a two coat system using paper tape. Gaps in excess of 4mm should be pre-filled with a base compound.

Installation:

- Apply compound to both sides of internal corner using a 75mm broadknife.
- Measure and cut reinforcing tape, fold along centreline and bed into corner, using a 50mm corner taping tool.
- Apply a skim coat of compound over tape.
- When dry apply a second coat of compound with the broad knife, then finish with a 100mm corner finishing tool, feathering beyond edges of first coat.
- Allow a minimum of 24 hours to dry (longer in cold, wet weather conditions).
- When thoroughly dry, lightly sand to a smooth finish with sanding mesh or 150–220 grit paper, depending on the sanding hardness of finishing compound used.

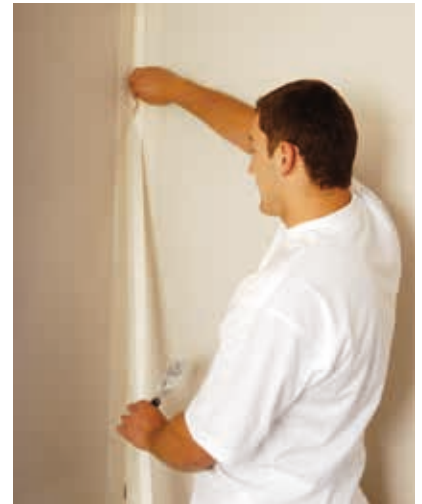
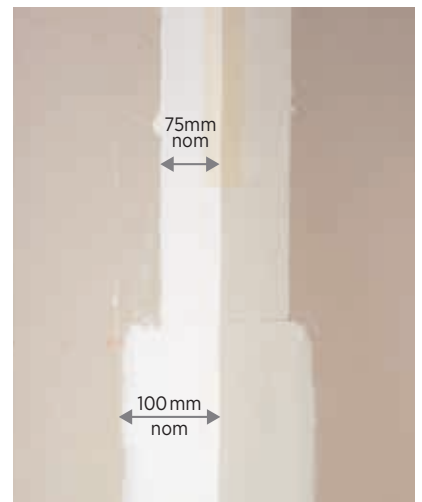
**1. Apply base compound****2. Bed tape****3. Apply second coat****4. Internal corner jointing system**Figure 82: **Stopping Internal Corners**

» JOINTING

EXTERNAL CORNERS

External corners should be strengthened with perforated metal angles then jointed and finished with a three coat system.

Suitable metal angles include Rondo Corner Beads P01 or P32:

Installation:

- Cut metal angle to length and position so that the angle is both straight and in line with the wall surfaces. Ensure that there is a 10mm gap left at the concrete floor to avoid rust.
- Fix with nails or staples at maximum 300mm centres along each face with nails opposite each other.
- Stop and finish with a three coat system as per jointing specification.
- Ensure that the first coat of compound covers approx 150mm of angle faces and is forced through the perforations.
- The second coat should extend approx 200mm from the corner.
- The final coat should extend approx 280mm from the corner with the edges feathered out.
- Ensure that the final coat is built up to the corner.
- Allow a minimum of 24 hours to dry (longer in cold, wet weather conditions).
- When finishing compound is thoroughly dry, light sand to a smooth finish with sanding mesh or 150–220 grit paper, depending on the sanding hardness of finishing compound used.

Other beads and angles (Shadowline, Stopping Angle etc) should be finished in the same manner.



1. Cut angle and fix to sides of corner @ 300mm ctrs



2. Apply first coat to both corner faces



3. Apply second coat to corner faces



4. Apply third coat to corner faces

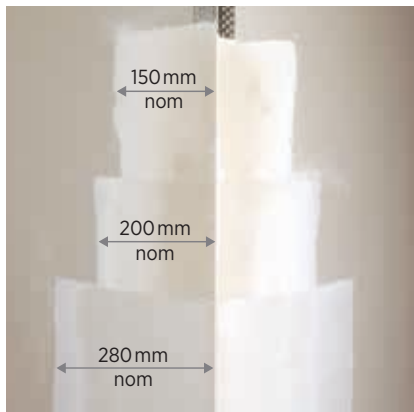

5. External corner jointing system

Figure 83: Stopping External Corners

TOOLS AND ACCESSORIES

A wide range of plastering tools and accessories is available through USG Boral outlets, including:

- Power Tools
- Fasteners
- Joint Knives
- Sanding tools
- Trowels
- Mechanical jointing tools
- Plasterers trestles and scaffolding.

Stainless steel jointing tools are recommended for the best possible finish and service longevity.

Low cost plastic tools are also available and may be suitable where low cost or disposable tools are required.

Tools should be cleaned in water before compounds have fully set and stainless steel tools given a light rub with an oiled cloth to prevent rusting.

Plasterers trestles or scaffolding should be used to ensure correct working height.



Figure 84: **Plastering Tools and Accessories**

» TOOLS AND ACCESSORIES

MECHANICAL JOINTING TOOLS

The following recommendations apply to mechanical jointing tools in addition to the general Jointing and Finishing specification.

BANJO BOX (MUD MACHINE)

- Jointing compounds recommended for use in Banjo Box include USG Boral SHEETROCK Taping Compound, RediBase and longer setting compounds such as the SHEETROCK EasySand 90 and BaseCote 90.
- Centre joint tape along the joint and using a broad knife press the tape down into the bedding compound.
- With the broad knife held approximately at 45 degrees to the board surface draw along the joint with enough pressure to remove excess compound and any air bubbles sandwiched beneath the tape (avoid dry spots under tape).
- Banjo Box ‘chaser’ (follow up stopper) should immediately follow to avoid dry-out. Ensure full width of recess is filled.
- Leave sufficient compound under the tape to achieve a good bond.
- Immediately apply a skim coat of base compound. This reduces the possibility of the tape edge curling or wrinkling which could lead to edge cracking (especially in hot, dry conditions).

FLAT BOXES (200mm, 250mm OR 300mm)

- Automatic boxes distribute the correct amount of joint compound over flat surfaces. All flat boxes have an adjustable setting that automatically crowns the joint.
- When second coating with 200mm box avoid too much take off; if following through with a broad knife, this will ensure that joint is flat.

NOTES:

- Beware of creating hollow joints when following through with a broad knife.
- All topping compounds will shrink back if second coat is hollow.
- Ensure box setting cam is set correctly to compensate for any out of plane frame undulations (ie uneven trusses or centre row wall noggings). Regularly change box blades and skid plates to avoid uneven joint finish.



Figure 85: Banjo Box Application



Figure 86: Flat Box Application

DECORATING PLASTERBOARD LININGS

GENERAL REQUIREMENTS

USG Boral plasterboard linings are an excellent base for:

- Painting
- Wallpapering
- Special finishes.

When preparing and decorating plasterboard surfaces, ensure that only high quality paints, wallpapers etc are used and applied in accordance with the manufacturer's instructions.

If using semi-gloss or gloss paint, it is recommended that plasterboard surface is finished to a Level 5 standard as these paints tend to highlight surface variations.

Take care, when sanding and finishing joints and fastener heads, to avoid scuffing the plasterboard surface adjacent to the jointed areas.

SURFACE PREPARATION

Make sure USG Boral plasterboard linings are dry and free of dust, oil, or greasy stains before decorating surfaces. Correct visible surface variations with an approved filler.

PAINTING

When painting plasterboard walls and ceilings, follow the procedures set down by the Australian Standard AS/NZS 2311 *The painting of buildings*.

It is recommended that a coat of quality sealer undercoat be applied to the plasterboard surface prior to the application of subsequent coats of paint. Sealer undercoat should be allowed to dry, lightly sanded and dusted down prior to the application of subsequent finish coats.

The chosen proprietary brand sealer undercoat should be formulated to fulfil the following functions:

- Equalise variations in porosity over the entire surface.
- Stop the migration or bleeding of chemicals from the substrate which could affect the appearance of the finishing coat.
- Conceal the difference in texture between the paper and the joints.

NOTES:

- Plasterboard linings should be sealed as soon as practical to minimise the risk of paper discolouration.
- Solvent borne sealers are recommended for plasterboard surfaces that may have discoloured due to prolonged exposure to ultraviolet light.
- If plasterboard linings are painted using airless spray, all paint coats should be back rolled while wet. The lack of back rolling when painting by airless spray may result in excessive paper nap raising.
- Overthinning paint may cause banding.

AVOIDING GLANCING LIGHT EFFECTS

When finishing USG Boral plasterboard linings consider the effects of glancing light. Walls and ceilings that seem perfectly flat in diffused light may appear rough when lit by light falling across the wall or ceiling surface.

Avoid glancing light problems through careful planning of lighting and paint application at the design stage (refer Glancing Light on page 13).

For more information, refer to the following publications:

- CSIRO, *Illumination and Decoration of Flat Surfaces*
- AWCIAZ, *Glancing Light*
- USG Boral, *Guide to Lighting and Decoration of Plasterboard*

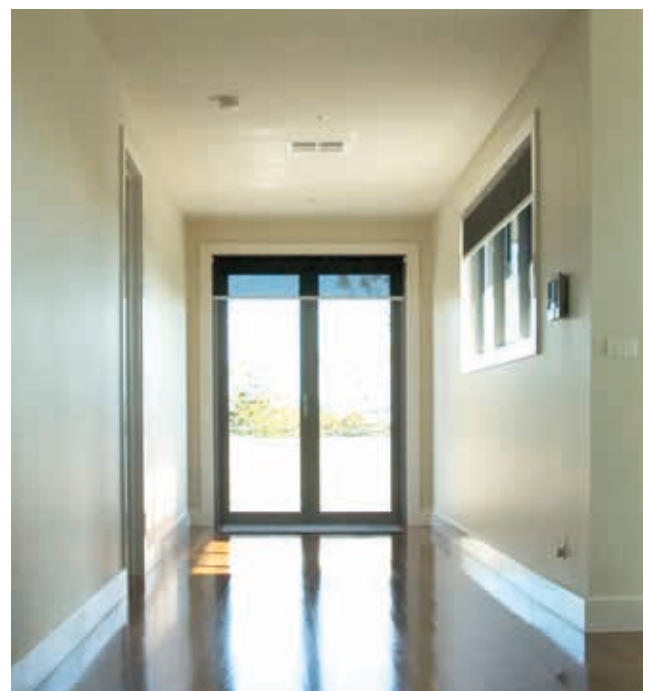

Figure 87: Glancing Light Situation

PRODUCT INFORMATION

See USGBoral.com for the most up-to-date product information.

NOTE

Products described here may not be available in all areas. Consult your USG Boral sales office or representative for information.

SALES ENQUIRIES

1800 003 377

TECHNICAL ASSISTANCE

TecASSIST™ – 1800 811 222

USGBoral.com

There are many variables that can influence construction projects, which affect whether a particular construction technique is appropriate. Before proceeding with any project, we recommend you obtain professional advice to ascertain the appropriate construction techniques to suit the particular circumstances of your project. We recommend you use qualified tradespersons to install this system.

The technical information contained in this manual was correct at the time of printing. Building systems, details and product availability are, however, subject to change. To ensure the information you are using is current, USG Boral recommends you review the latest building information available on the USG Boral website.

For further information, contact TecASSIST™ or your nearest USG Boral sales office.

UB1036-SYS 10/16

© 2016 USG BORAL. All rights reserved. The trademarks USG BORAL, INNOVATION INSPIRED BY YOU, TecASSIST, Unispan, Soundstop, Echostop, Firestop, Impactstop, Multistop, Flexiboard, Shaftliner, BaseCote, RediBase, LiteFinish, TopCote 550, FinalCote, PremiumBond, Wet Area System, WetStop, Fire+Wetstop and Wet Area Sealant are trademarks or registered trademarks of USG Boral Building Products or one or more of its affiliates. SHEETROCK, Easy Sand, Total Lite and Diamond Veneer are trademarks owned by United States Gypsum Company and used under license. FIBEROCK and Tuff-Hide are trademarks owned by USG Interiors Pacific Limited and used under license. X-Block is a registered trademark owned by Fletcher Building Holdings Ltd.NZ and used under license. USG Boral Building Products Pty Limited – ABN 84 004 231 976 251 Salmon Street, Port Melbourne, VIC. 3207